

Травкина Ж.А.

Сложи слово. 1 класс.

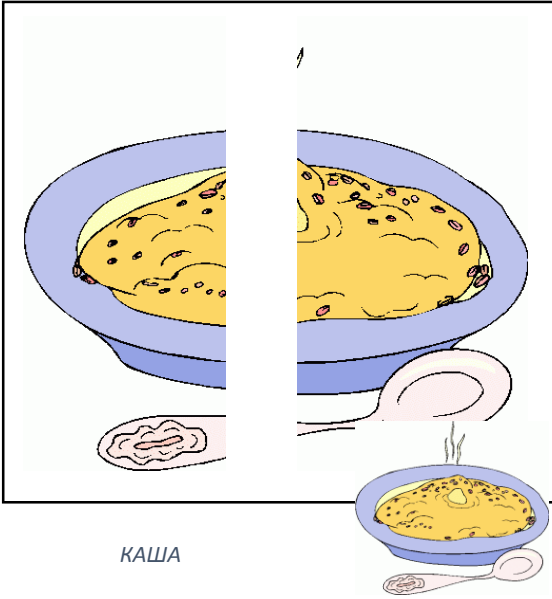

КАША



БАТА



ХАТА

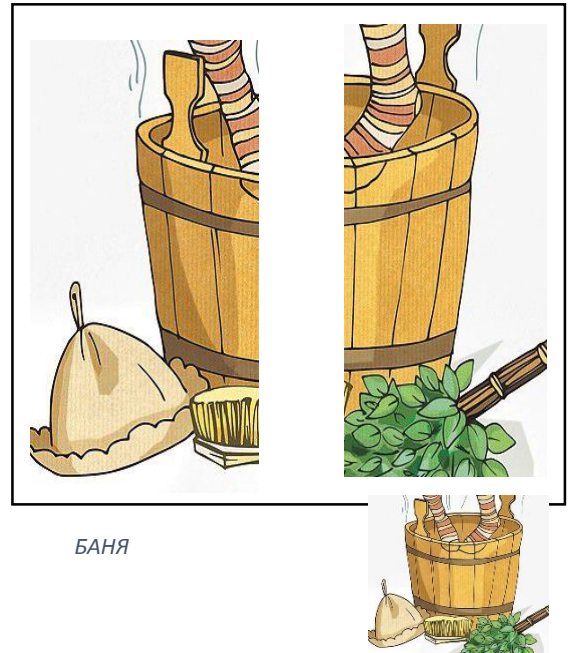

БАНЯ



ВАЗА



ДАЧА

Травкина Ж.А

Сложи слово. 1 класс.



ЖАБА



ЛАМА



МЯТА



ЧАША

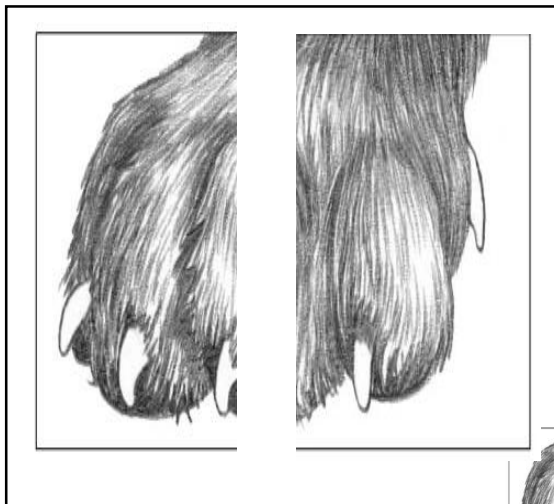

ЛАПА

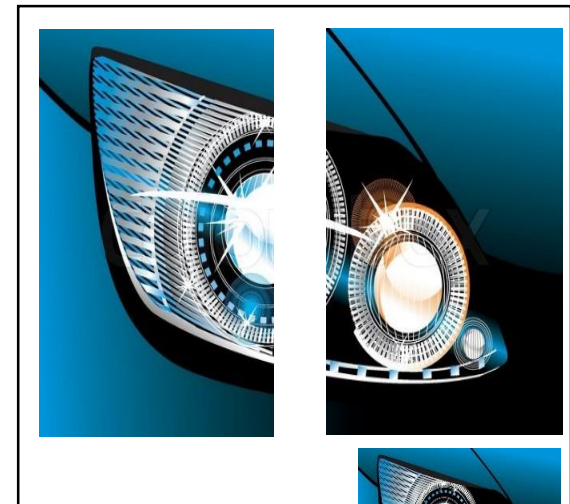

ФАРА

Травкина Ж.А

Сложи слово. 1класс.

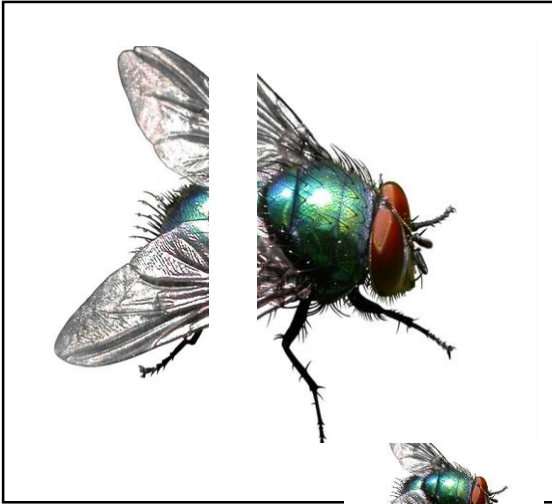

МУХА

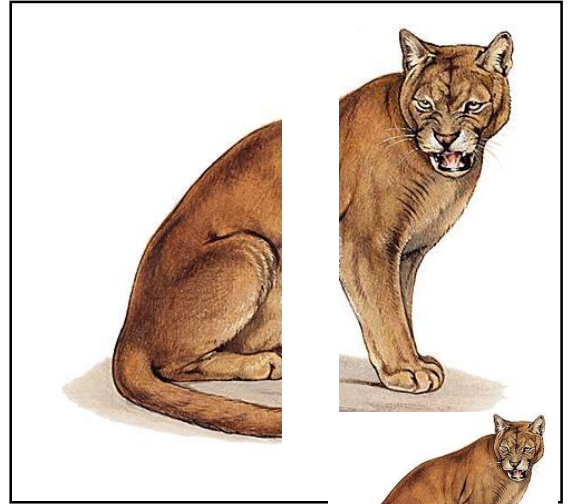

ПУМА



ТУЧА



ЛУПА

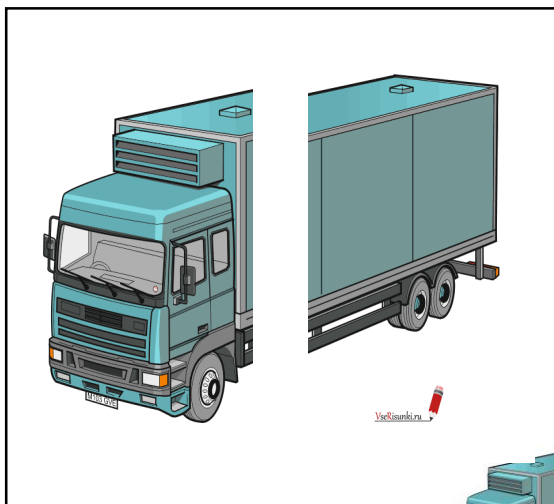

ФУРА

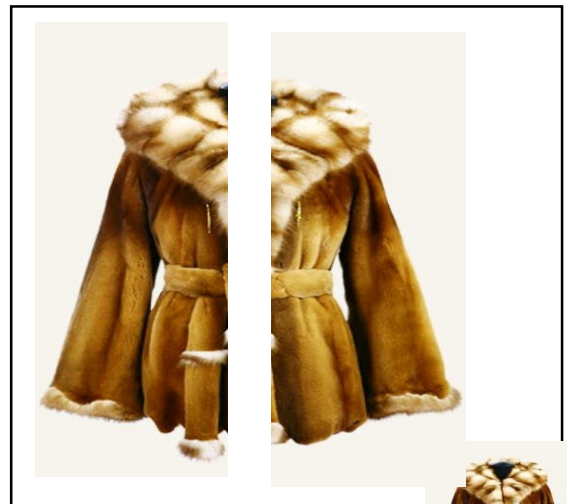

ШУБА

Травкина Ж.А

Сложи слово. 1класс.

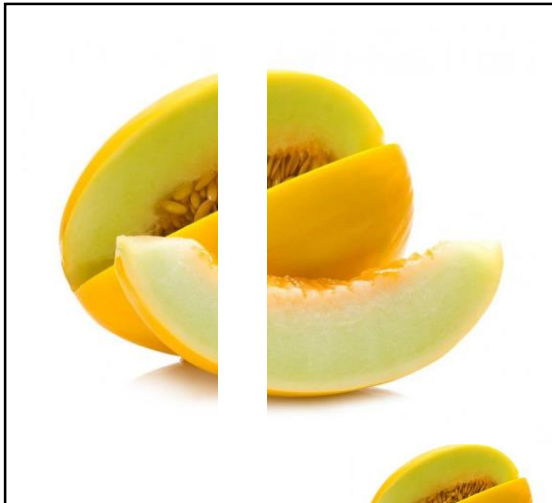

ДЫНЯ



РЫБА

Обыкновенный сазан (капл)

Обыкновенный сазан (капл)

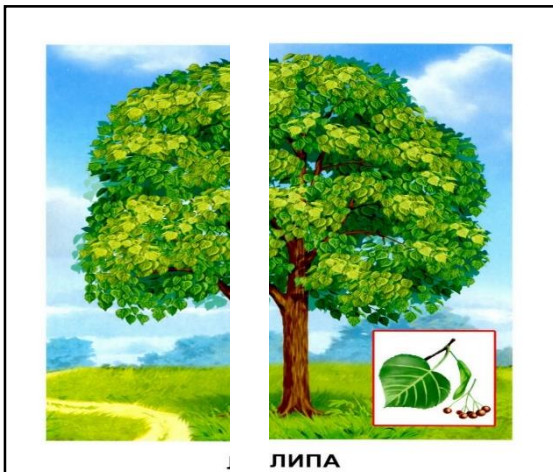

ЛИПА

ЛИПА



ЛИПА

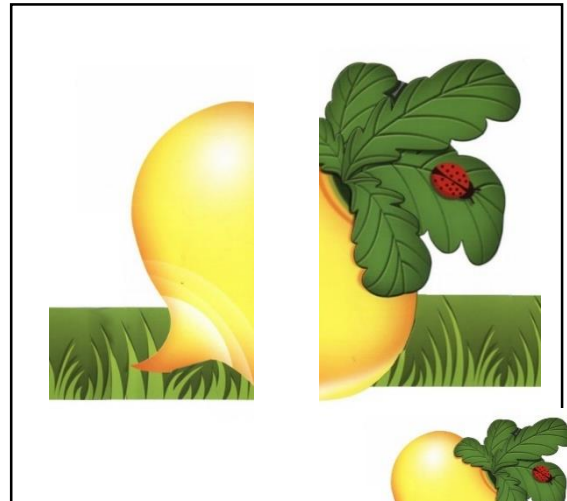

РЕПА



НОТА

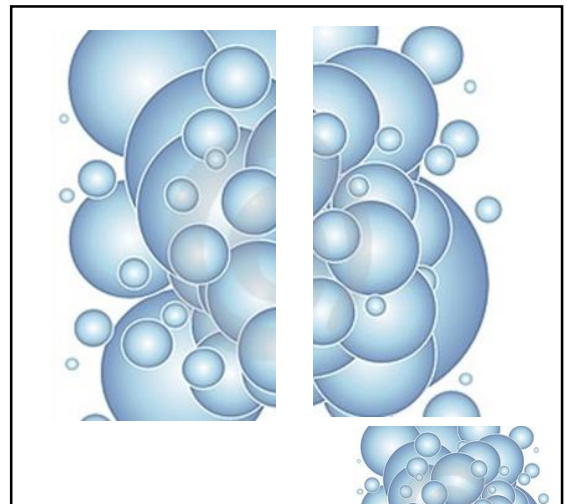

ПЕНА

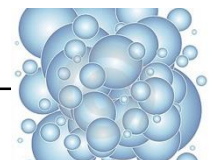

Травкина Ж.А

Сложи слово. 1класс.

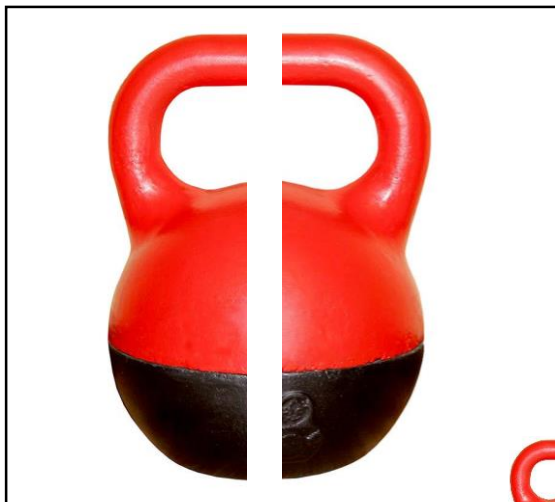

ГИРЯ

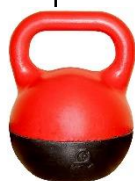

КУЧА



ШИНА



ЛУЖА



ПУЛЯ



ИВА



Травкина Ж.А

Сложи слово. 1класс.

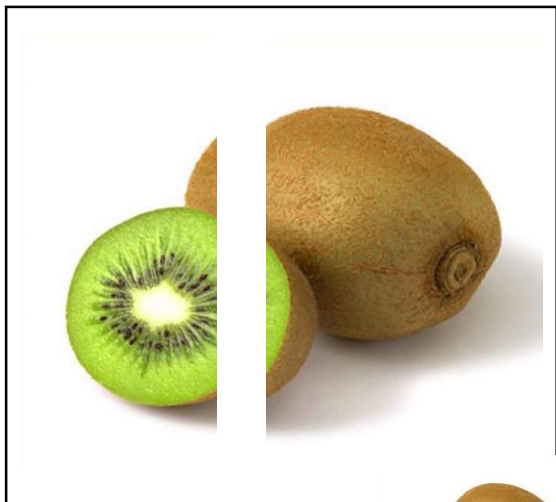

КИВИ

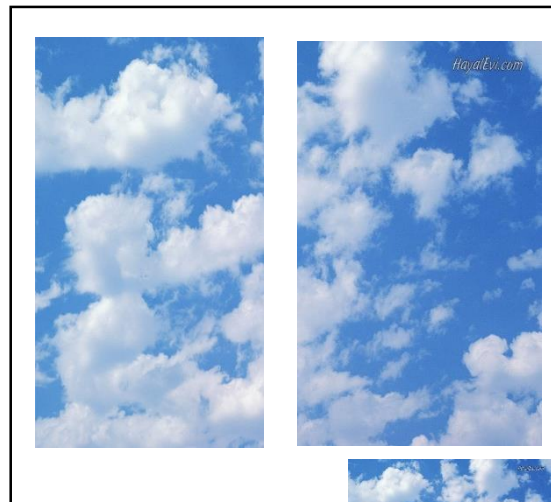

НЕБО



КОФЕ

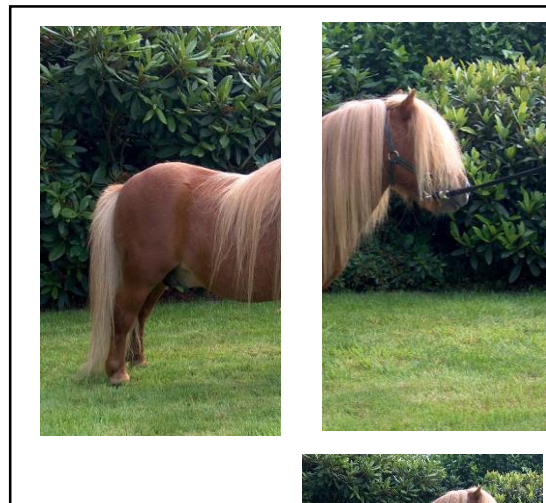

ПОНИ



КЕДЫ



МЯСО



Травкина Ж.А

Сложи слово. 1класс.

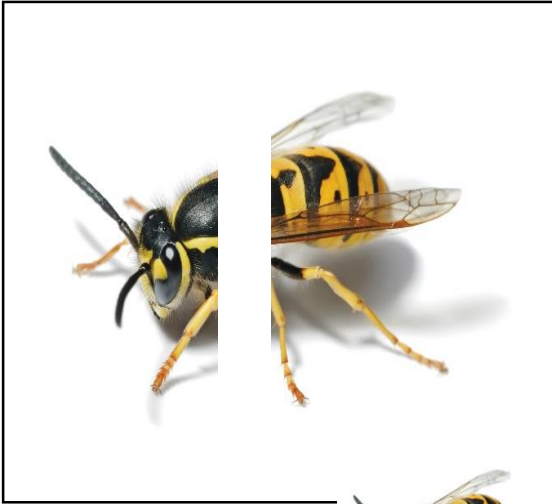

ОСА

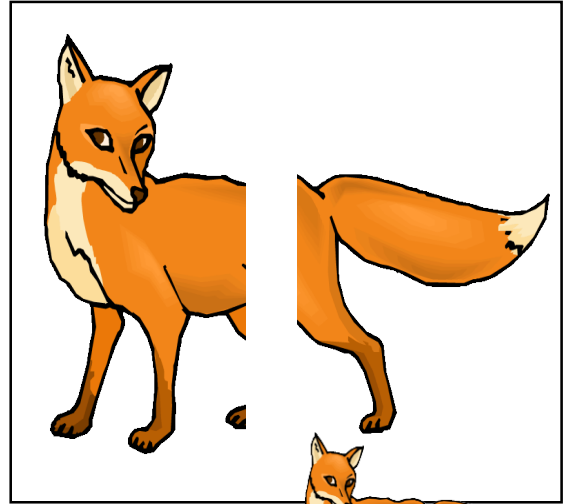

ЛИСА



МУКА



ЮЛА



ПИЛА

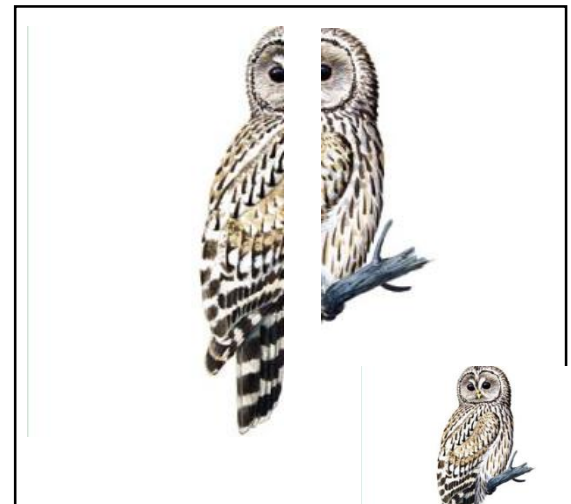

СОВА



Травкина Ж.А

Сложи слово. 1класс.

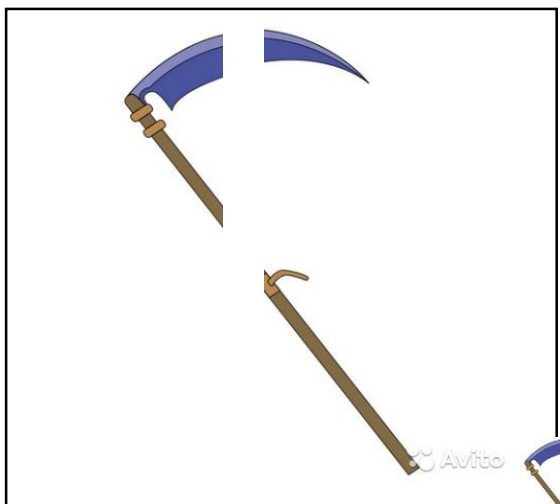

КОСА

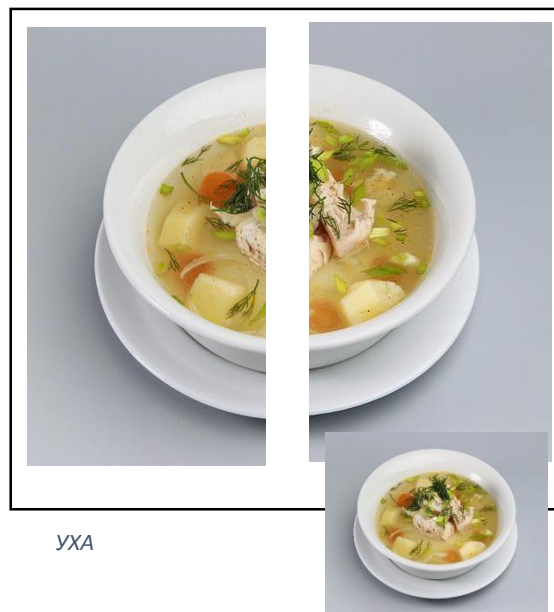

УХА

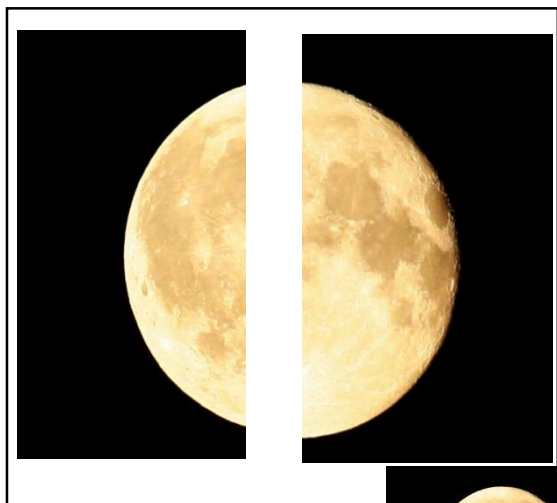

ЛУНА

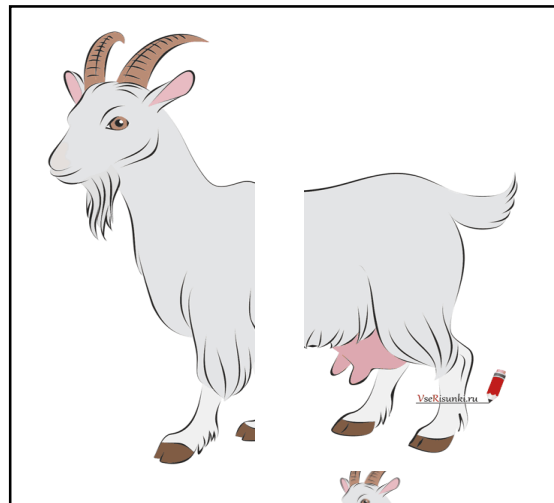

КОЗА

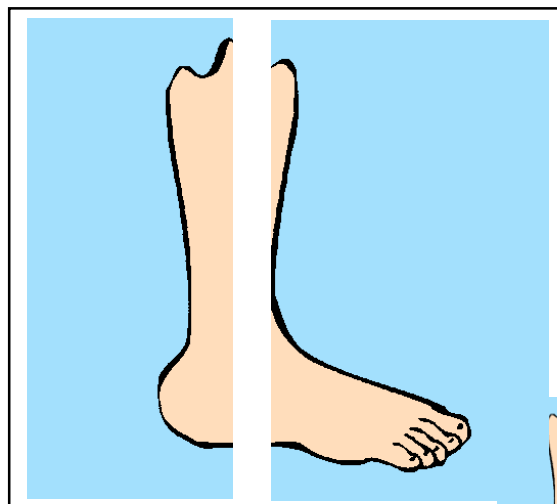

НОГА

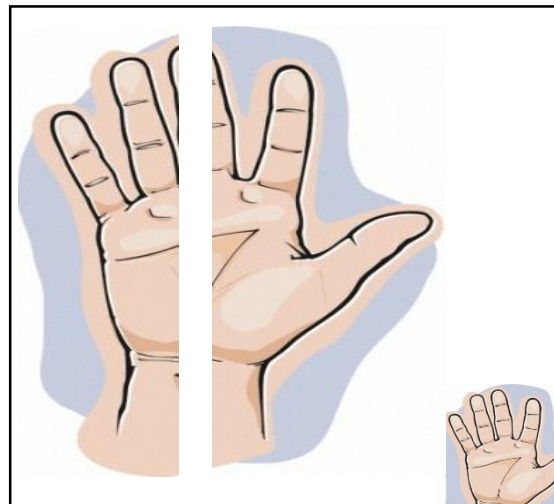

РУКА



Травкина Ж.А.

Сложи слово 2 класс.

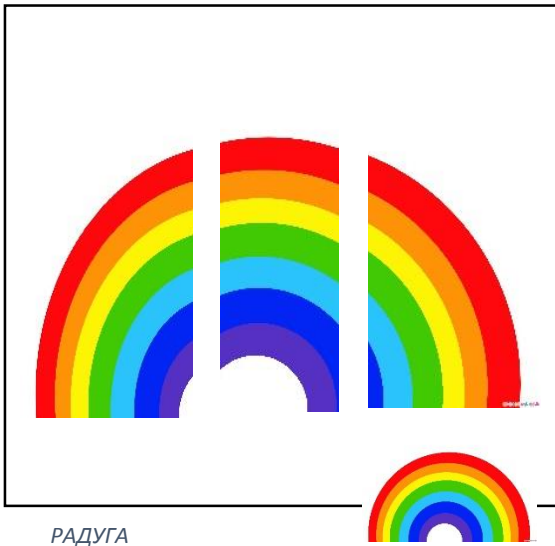

РАДУГА

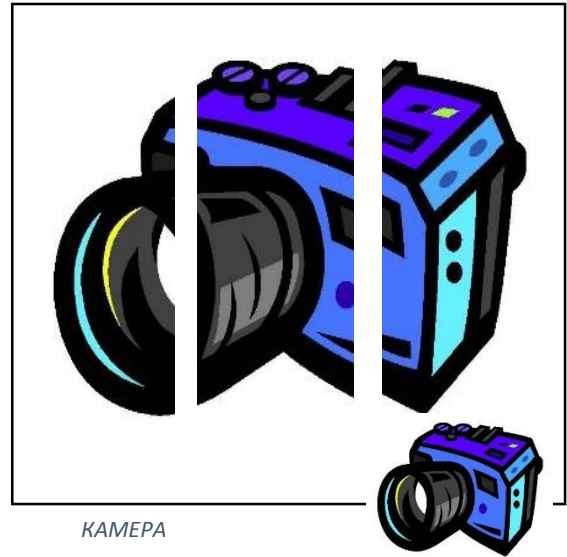

КАМЕРА

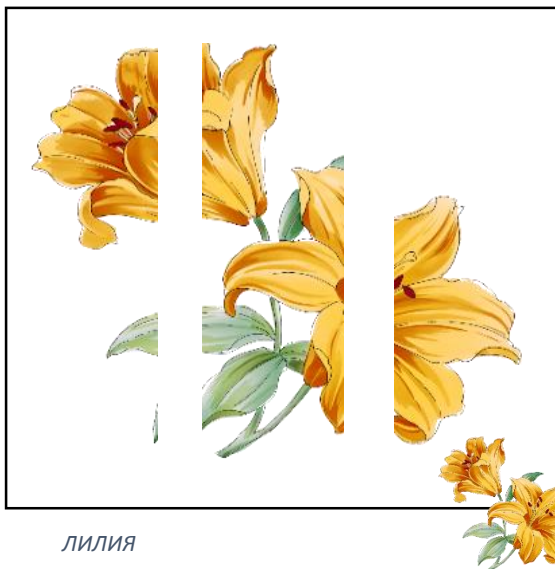

ЛИЛИЯ

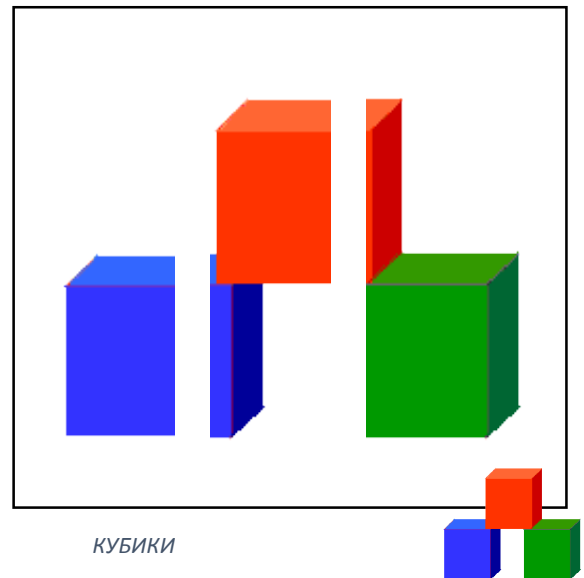

КУБИКИ

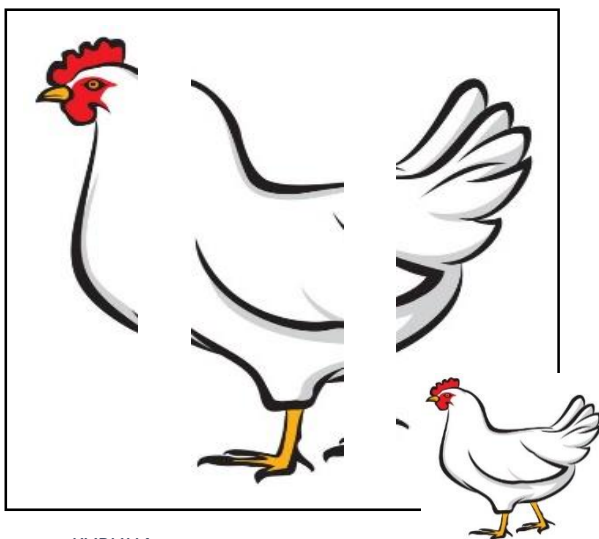

КУРИЦА

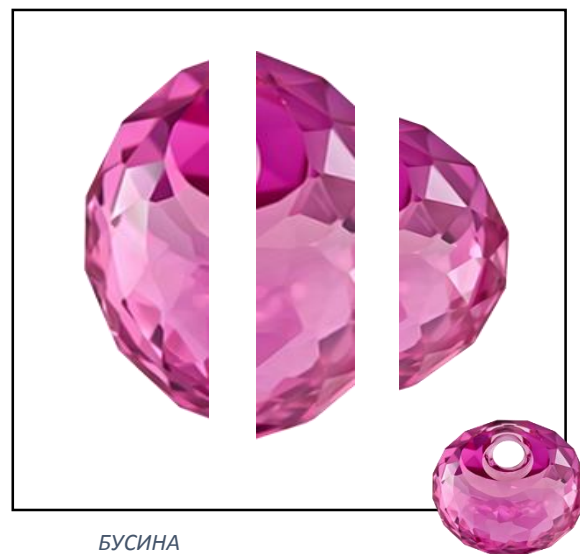

БУСИНА

Травкина Ж.А

Сложи слово. 2 класс.

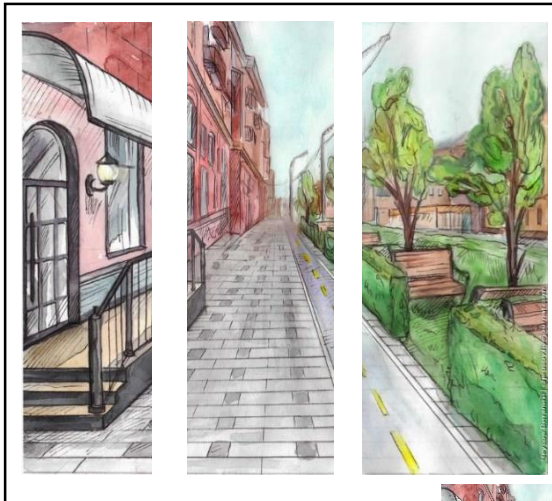

УЛИЦА

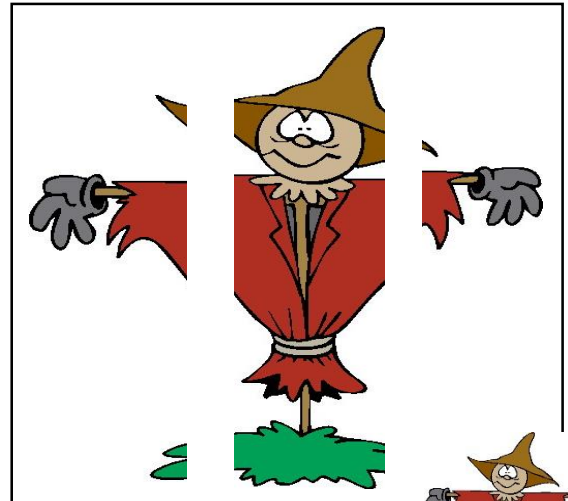

ПУГАЛО

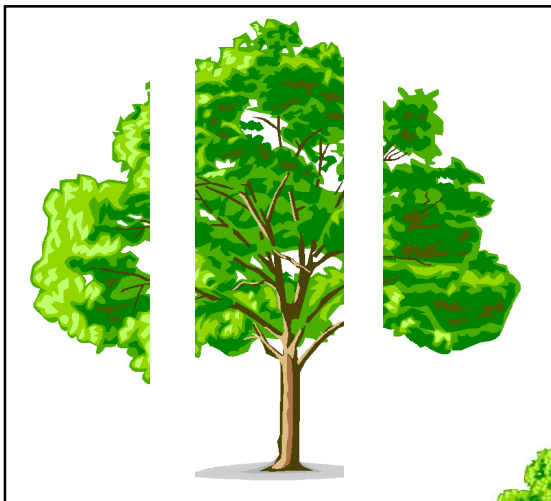
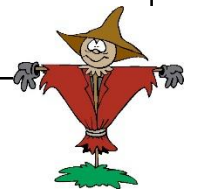

ДЕРЕВО

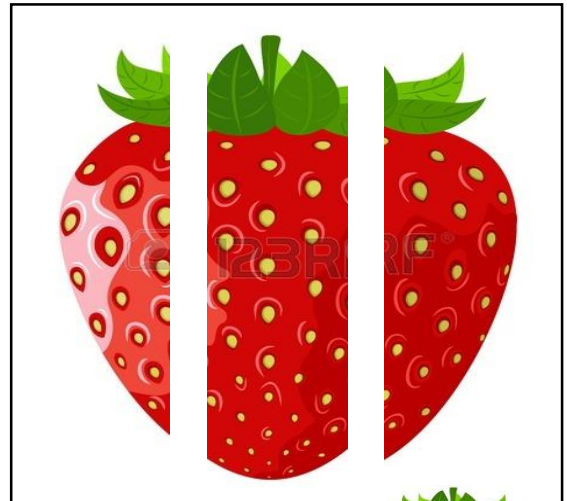

ЯГОДА

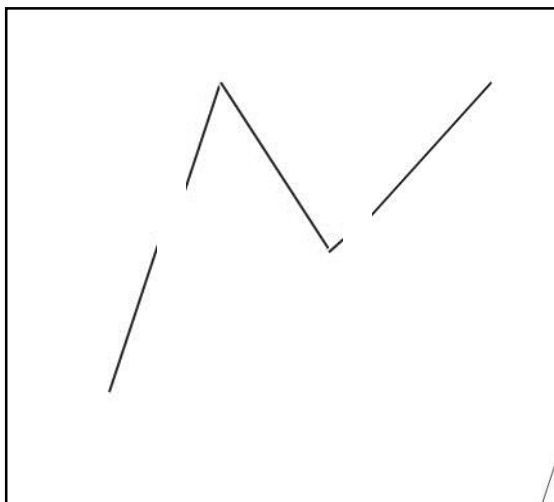

ЛИНИЯ

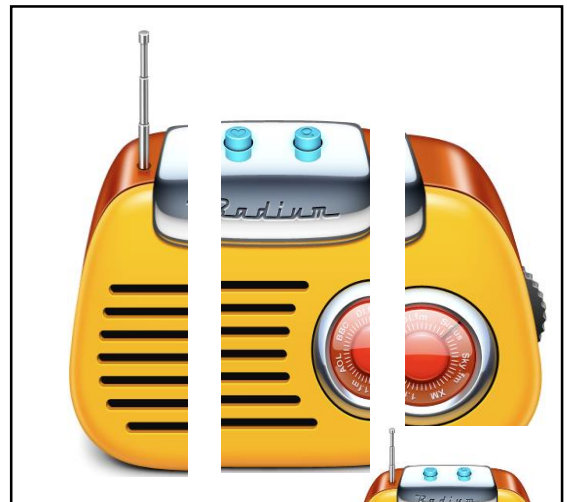
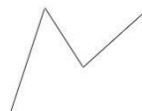

РАДИО



Травкина Ж.А

Сложи слово. 2 класс.



ПАНАМА



ПОМАДА

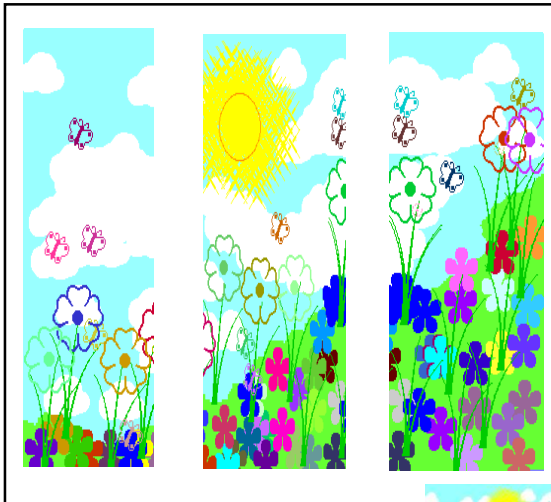

ПОЛЯНА

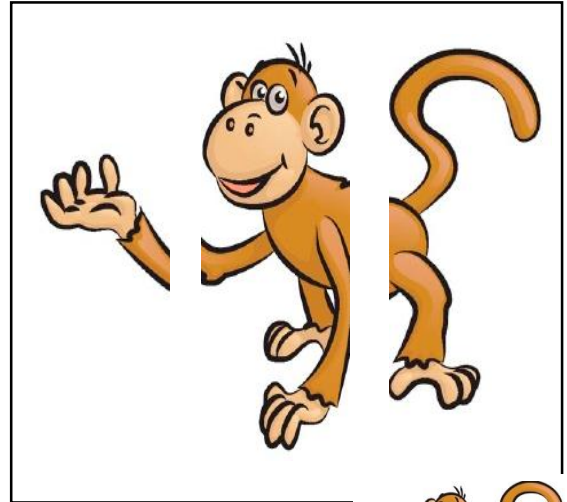

МАКАКА



ЛОПАТА



ПИЖАМА



Травкина Ж.А

Сложи слово. 2 класс.



МАЛИНА



КАБИНА

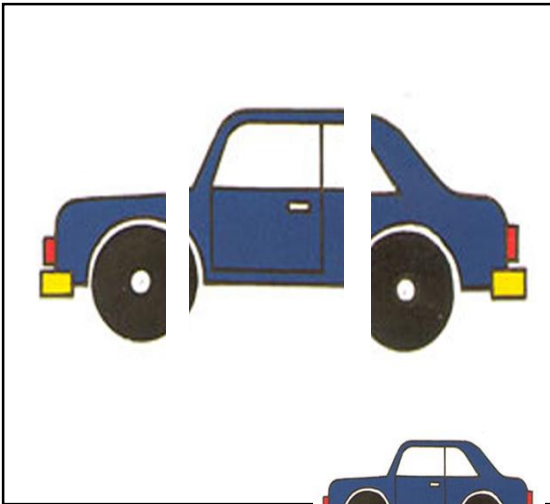

МАШИНА



МОНЕТА



ГАЗЕТА

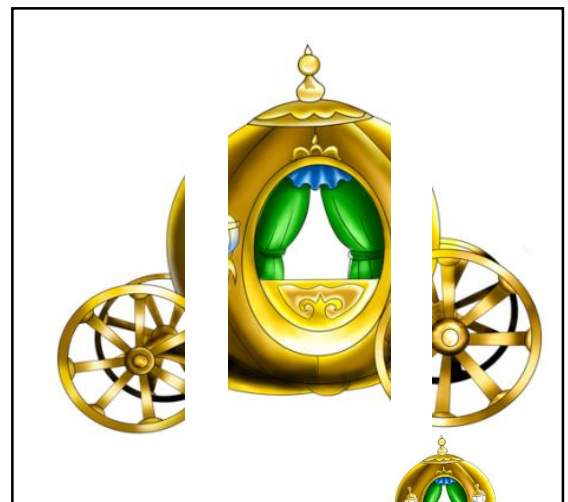

КАРЕТА



Травкина Ж.А

Сложи слово. 2 класс.



ПОСУДА



ТЕЛЕГА



ДУБИНА



РЯБИНА

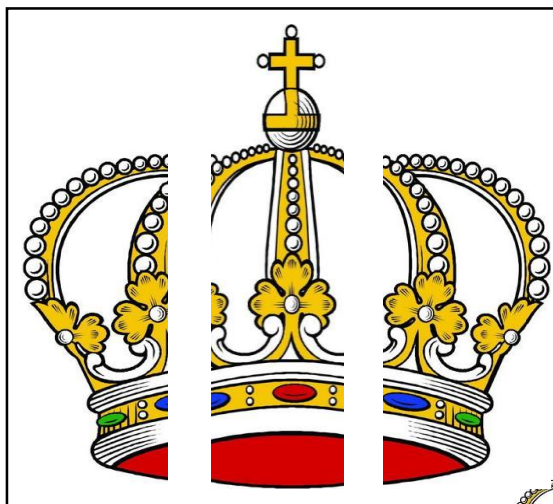

КОРОНА



ДОРОГА



Травкина Ж.А

Сложи слово. 2 класс.

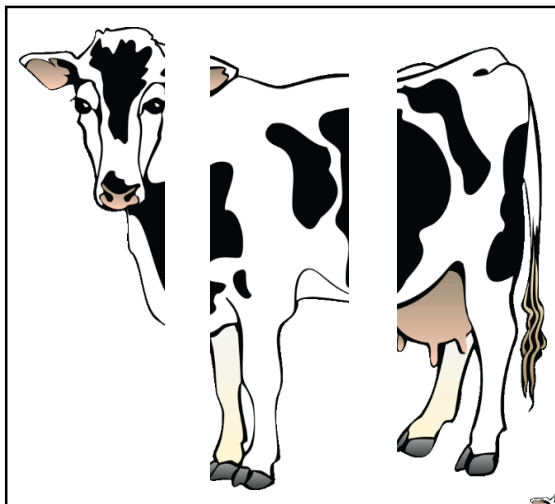

КОРОВА

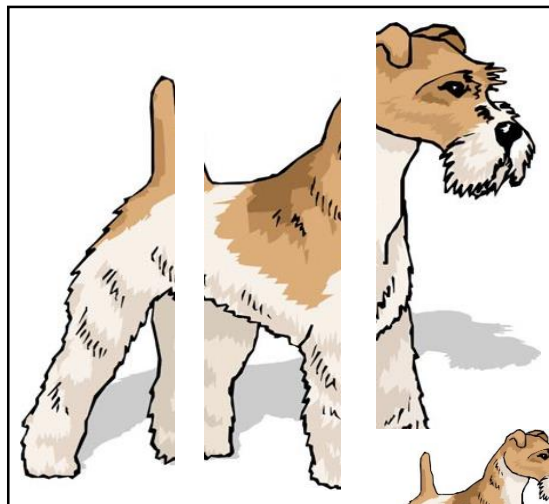
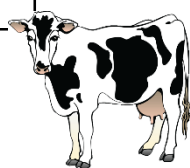

СОБАКА

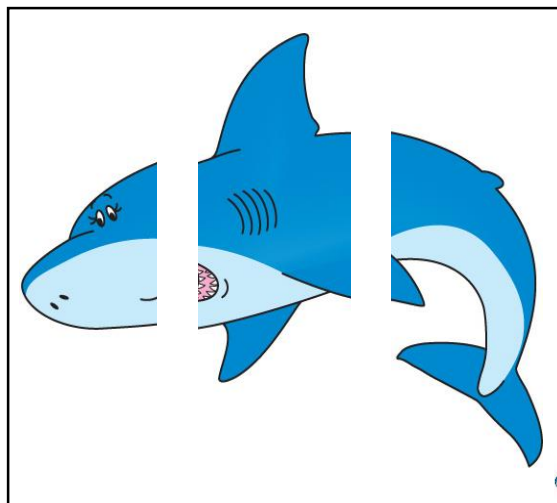

АКУЛА

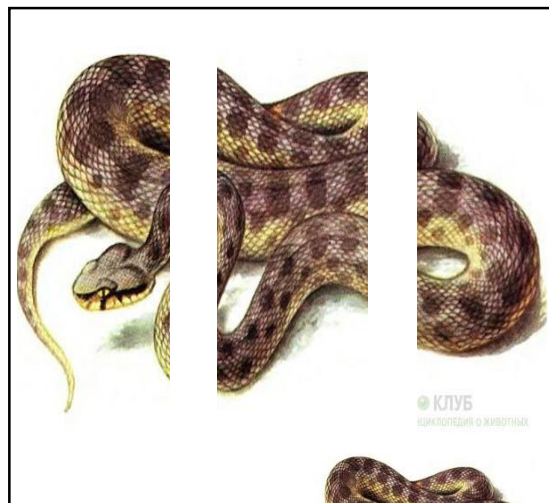
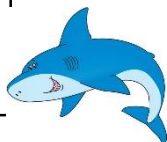

ГАДЮКА

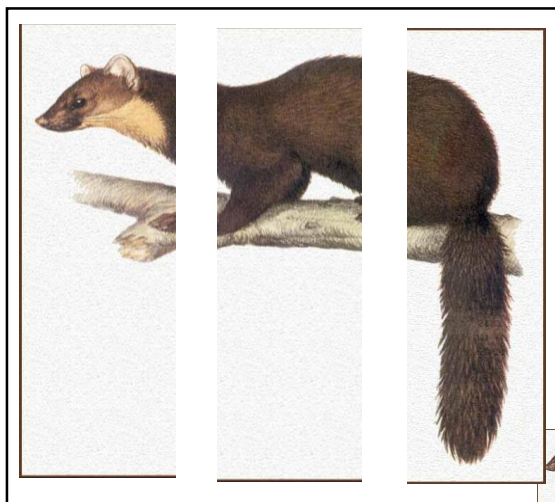

КУНИЦА

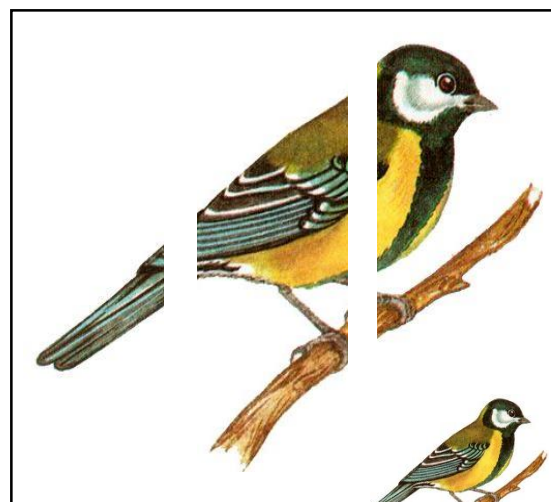
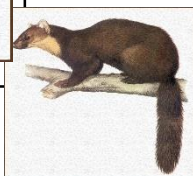

СИНИЦА



Травкина Ж.А

Сложи слово. 2 класс.



БИГУДИ



КОЛЕСО



МОЛОКО

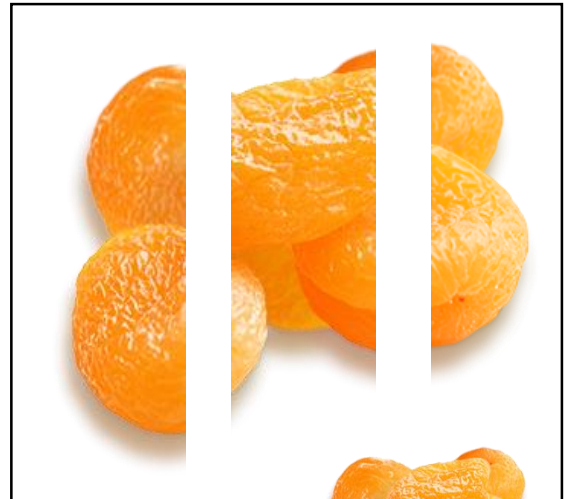

КУРАГА



КОУРА



КИМОНО



Травкина Ж.А

Сложи слово. 4 класс.



ПУФИК



КАТЕР

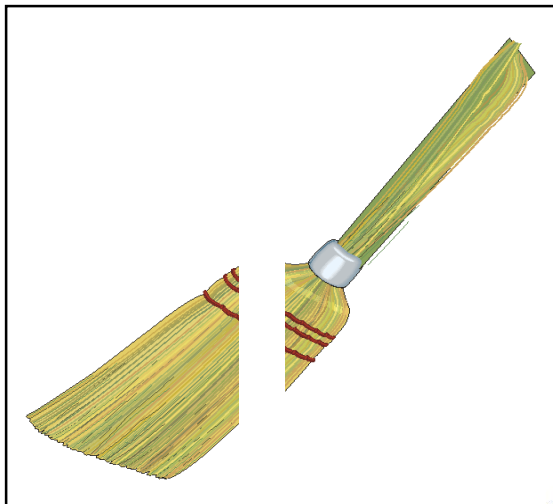

ВЕНИК

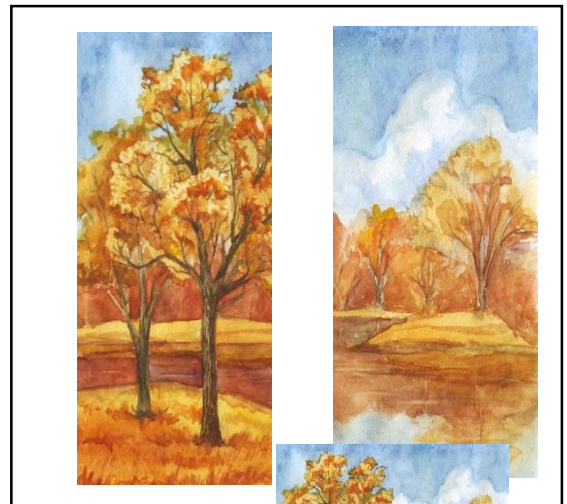

ОСЕНЬ



ФАКЕЛ

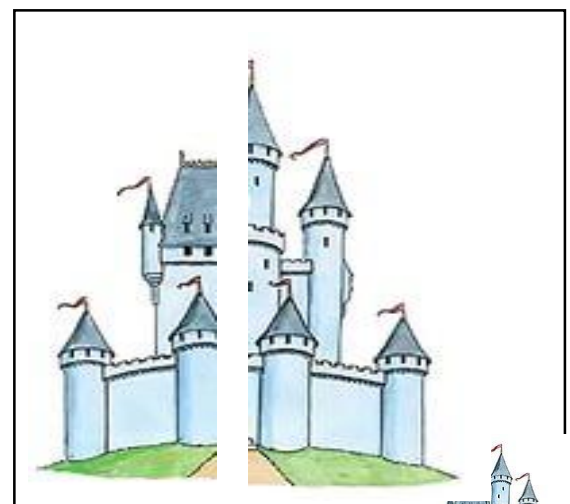

ЗАМОК





Травкина Ж.А

Сложи слово. 4 класс.

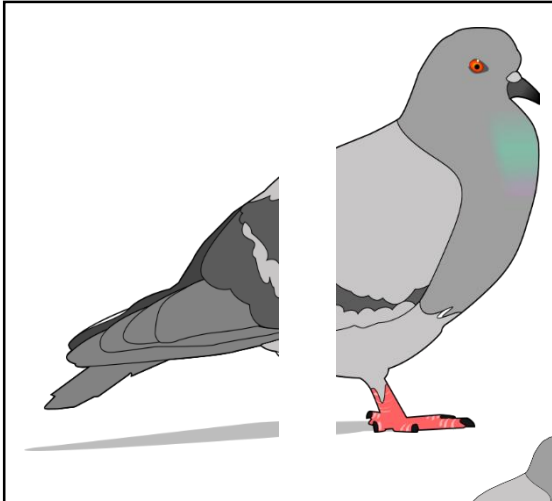

ГОЛУБЬ



ДЯТЕЛ

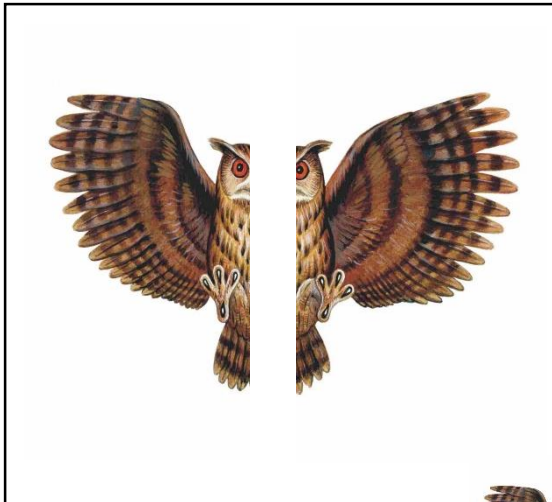

ФИЛИН

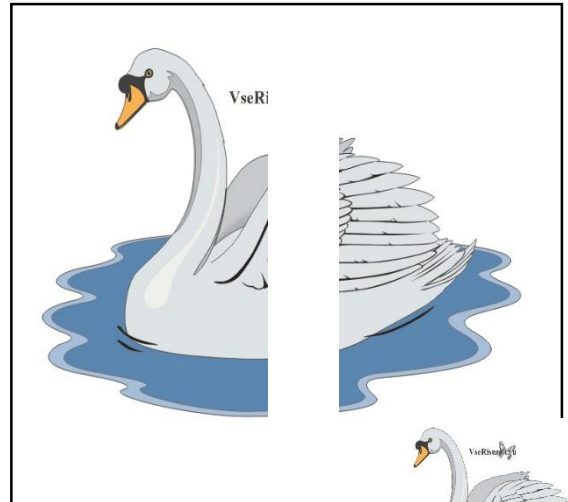

ЛЕБЕДЬ



СОКОЛ

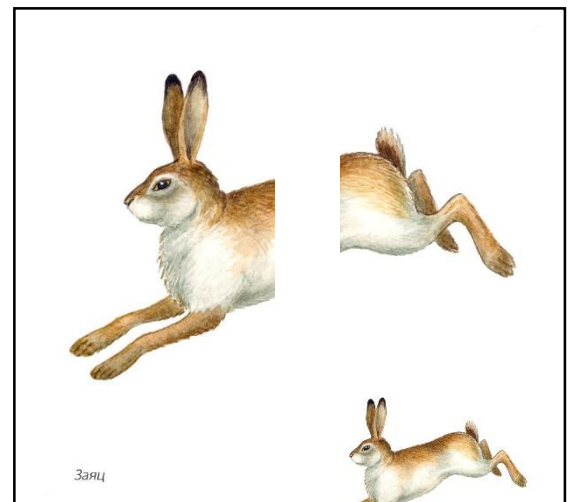

Заяц

ЗАЯЦ

Травкина Ж.А

Сложи слово. 4 класс.

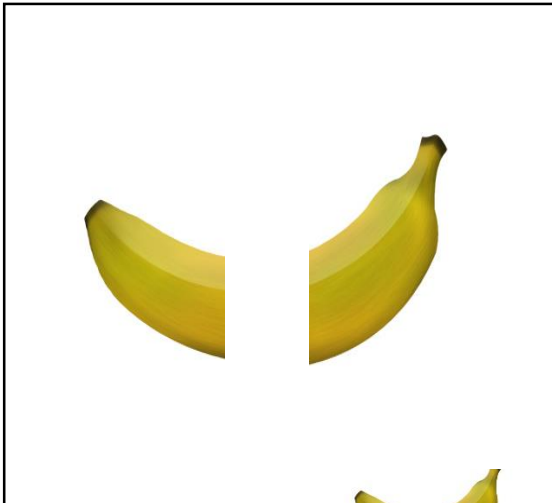

БАНАН

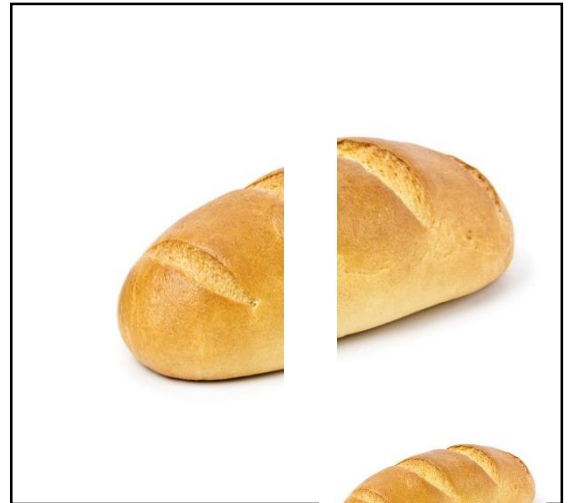

БАТОН

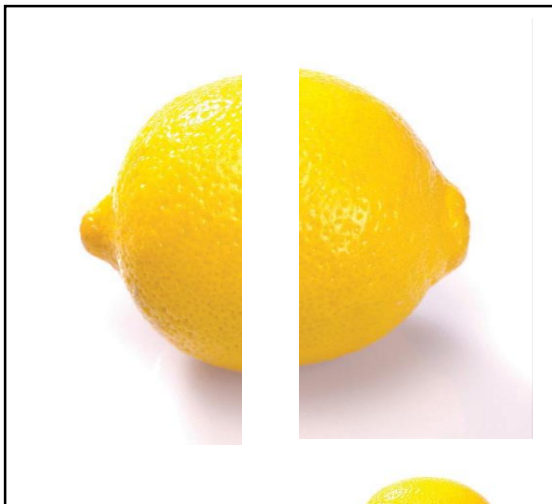

ЛИМОН

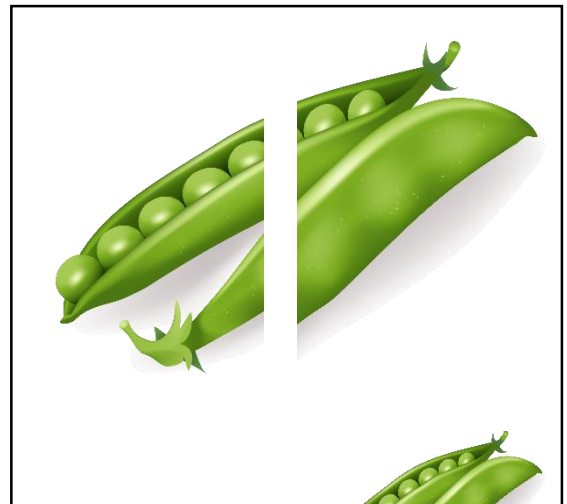

ГОРОХ

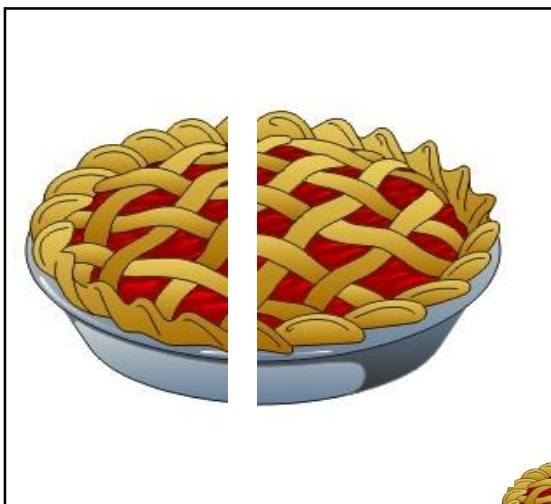

ПИРОГ



САЛАТ

Травкина Ж.А

Сложи слово. 4 класс.

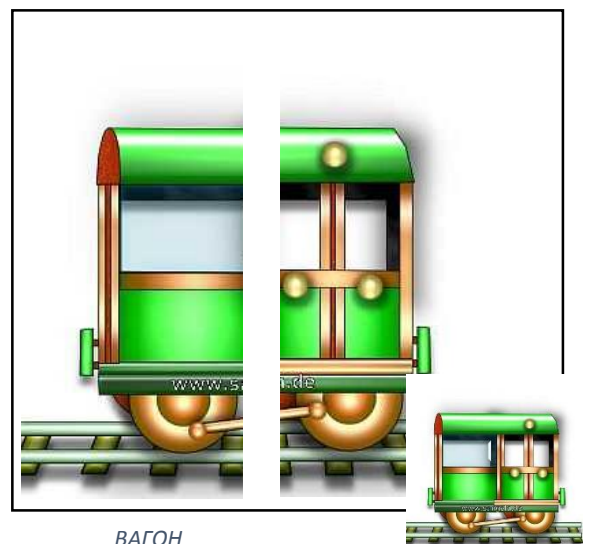
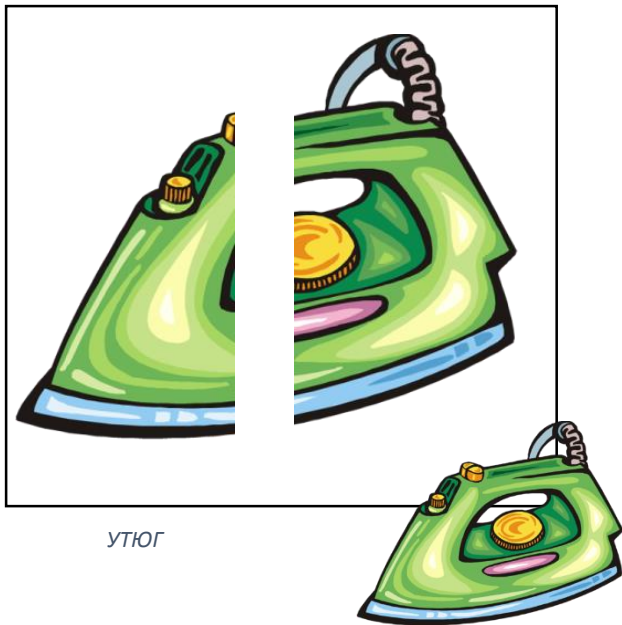
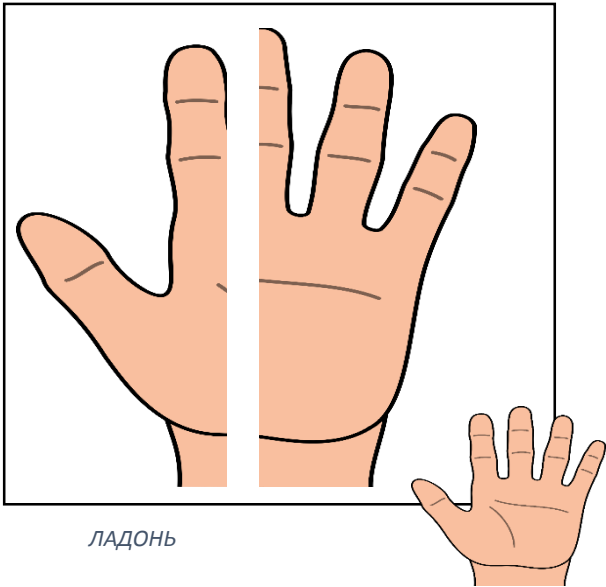

Травкина Ж.А.

Сложи слово. 4 класс.



ПАУК

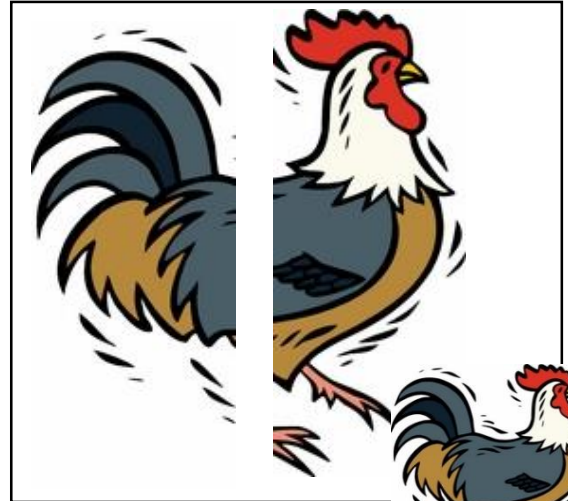

ПЕТУХ

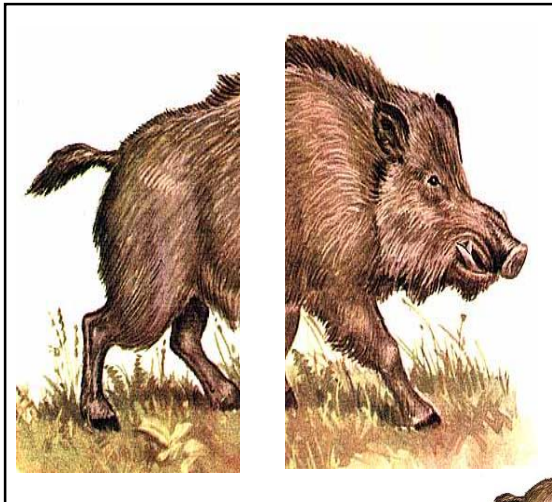

КАБАН

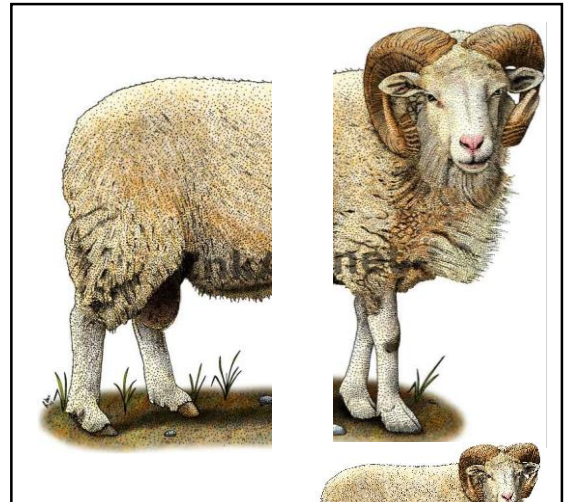

БАРАН

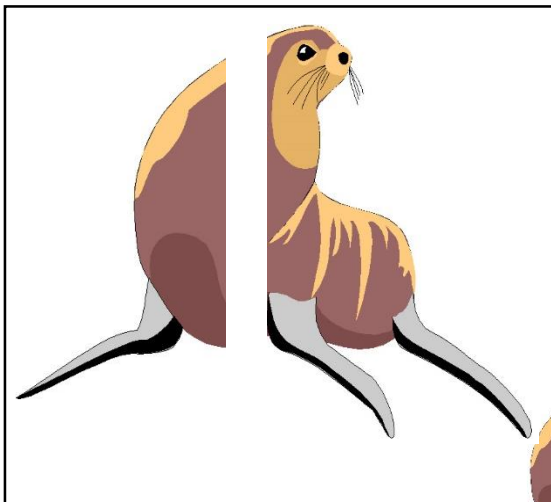
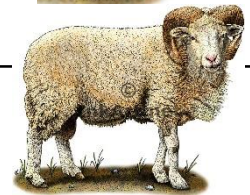

ТЮЛЕНЬ

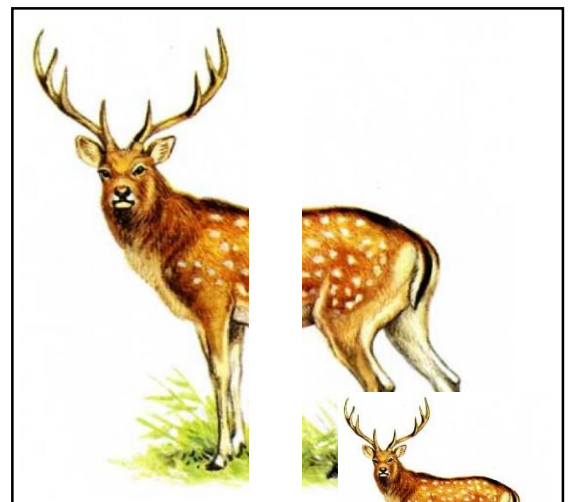

ОЛЕНЬ



Травкина Ж.А

Сложи слово. 4 класс.

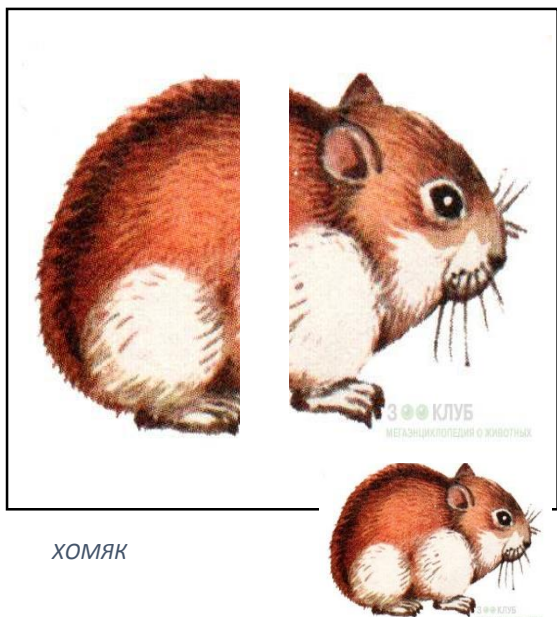

ХОМЯК

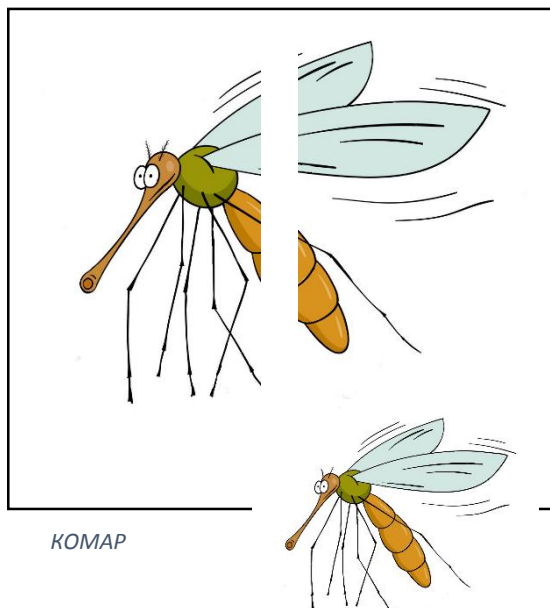

КОМАР



БИЛЕТ

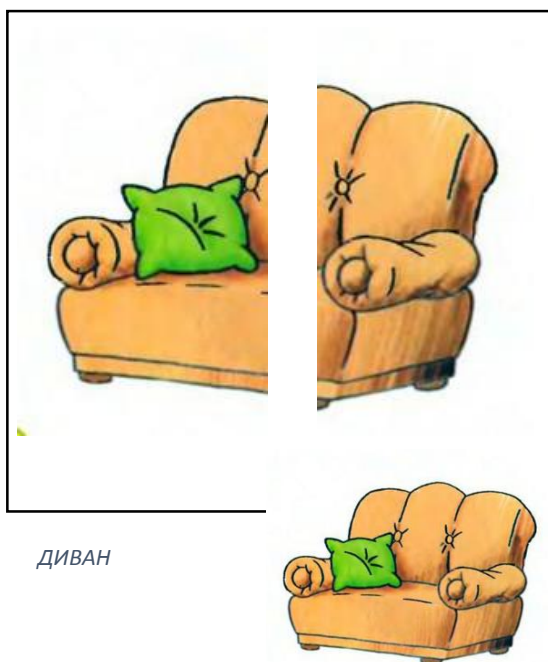

ДИВАН

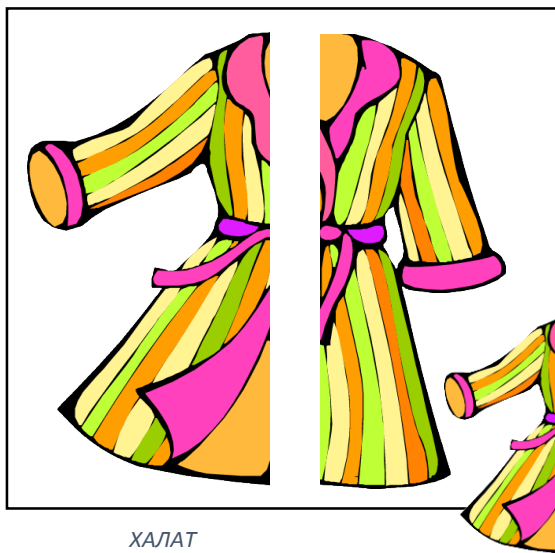

ХАЛАТ

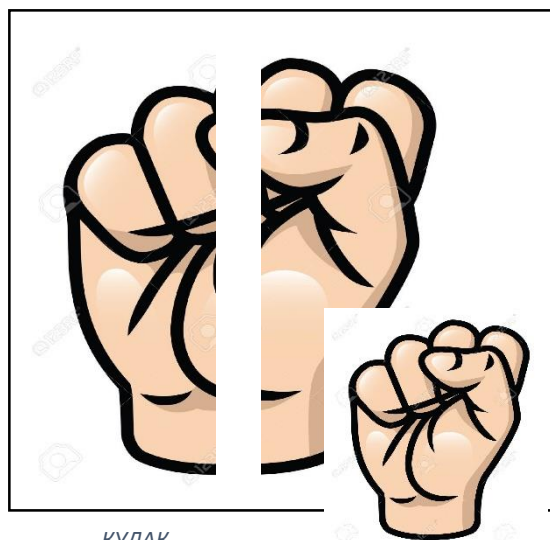

КУЛАК

Травкина Ж.А

Сложи слово. 5 класс.

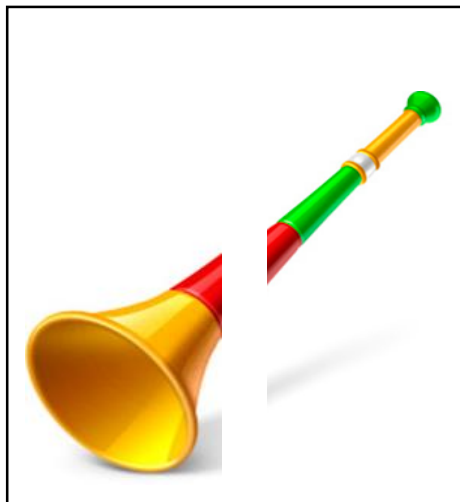

ДУДКА

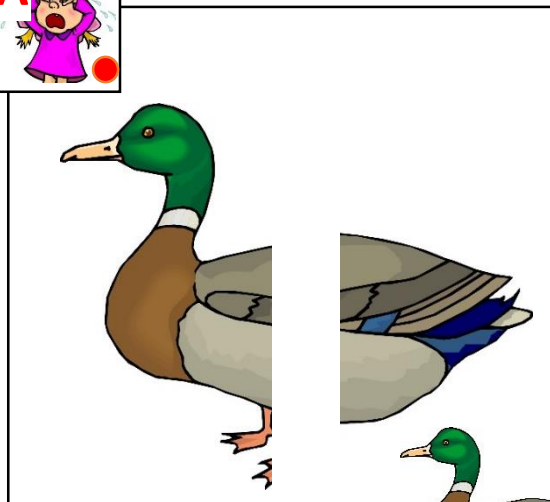

УТКА

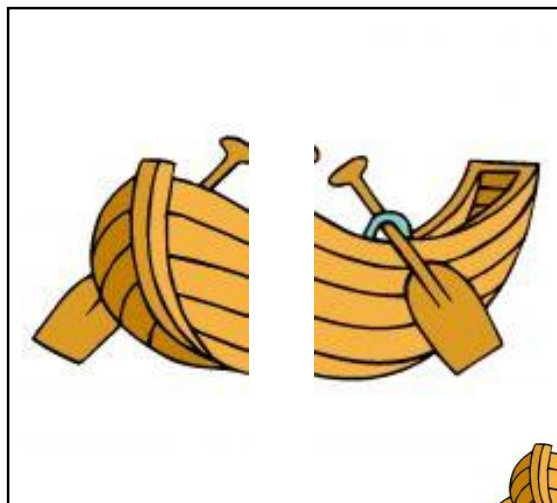
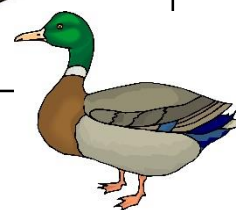

ЛОДКА

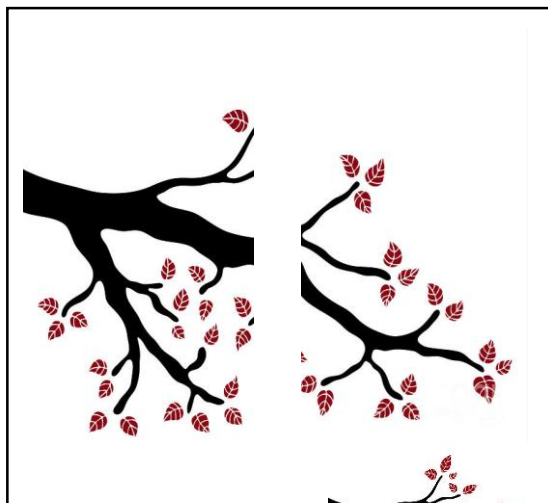

ВЕТКА

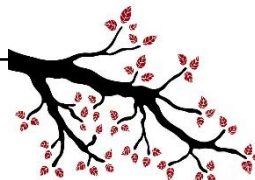

ЩЕТКА

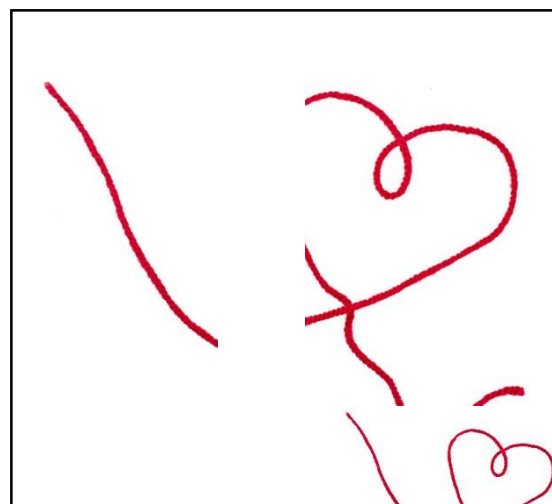

НИТКА

Травкина Ж.А

Сложи слово. 5 класс.



БАТКА

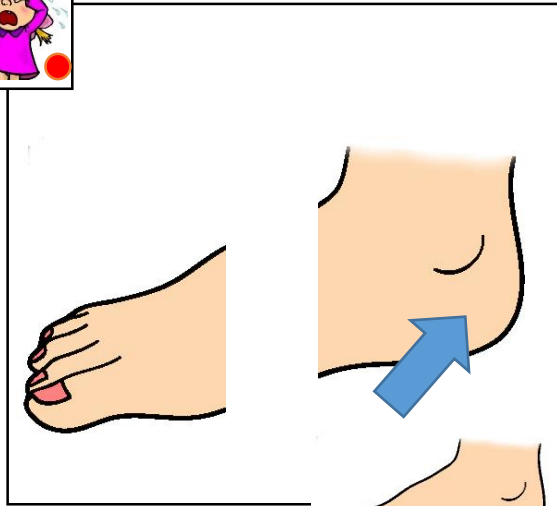

ПЯТКА

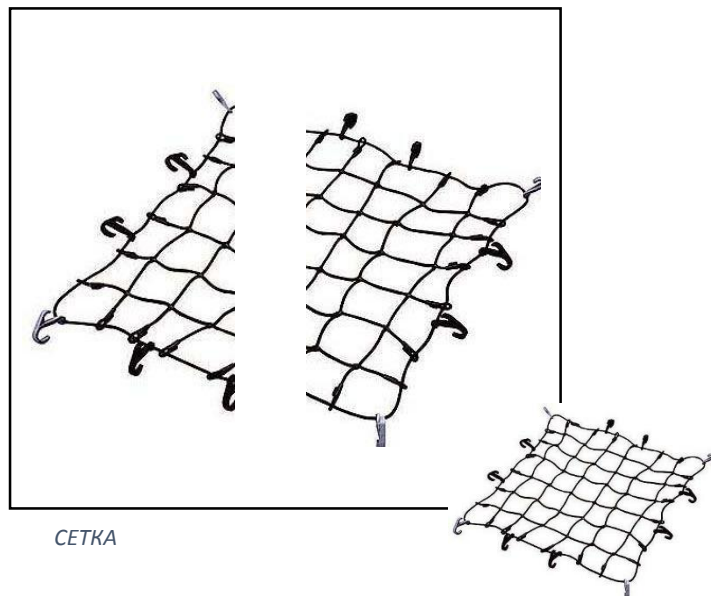

СЕТКА

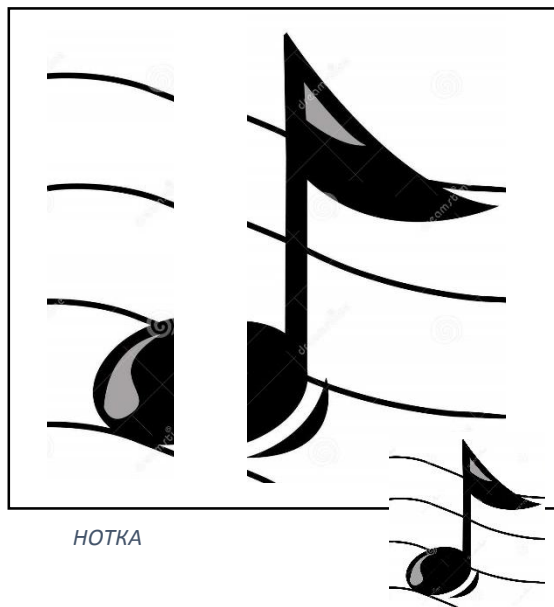

НОТКА

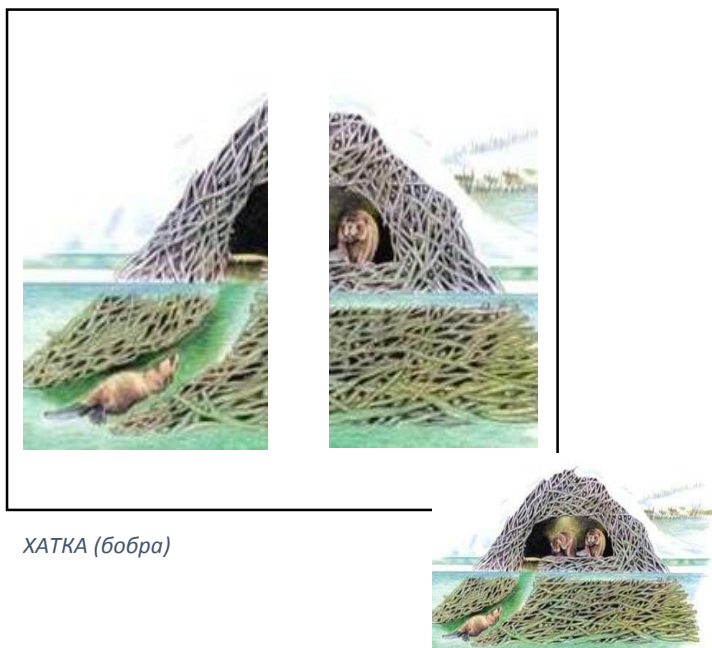

ХАТКА (бобра)

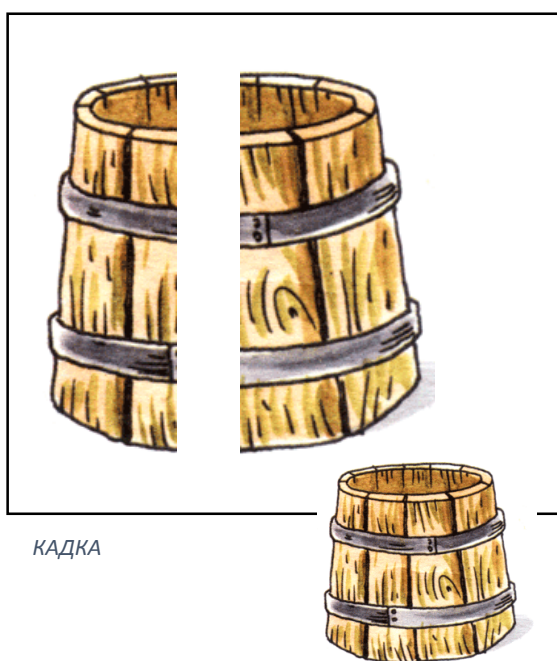

КАДКА



ШАПКА



ЮБКА



КЕПКА



ШУБКА

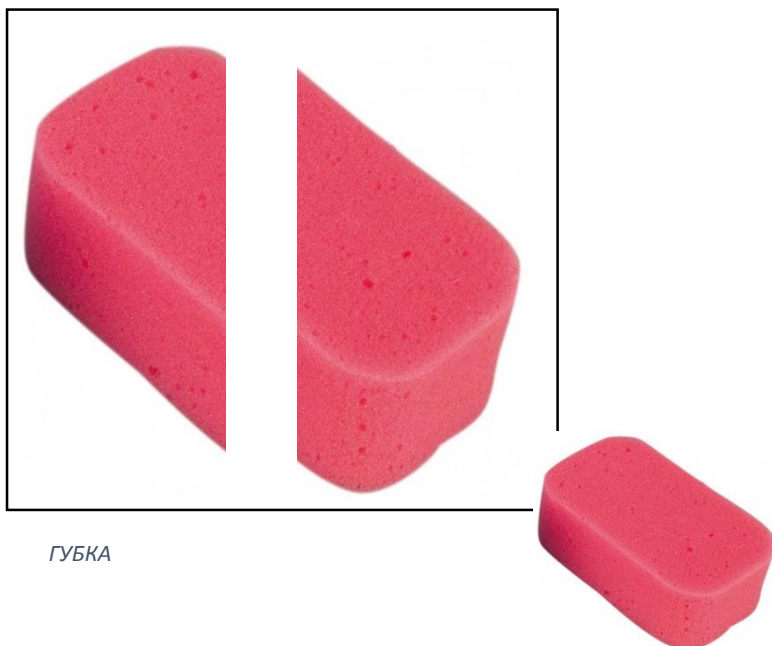

ГУБКА

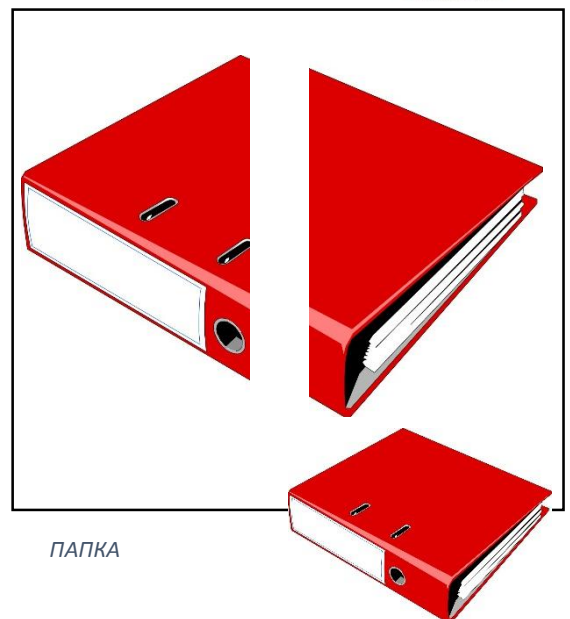

ПАПКА





ТЯПКА



РЕПКА

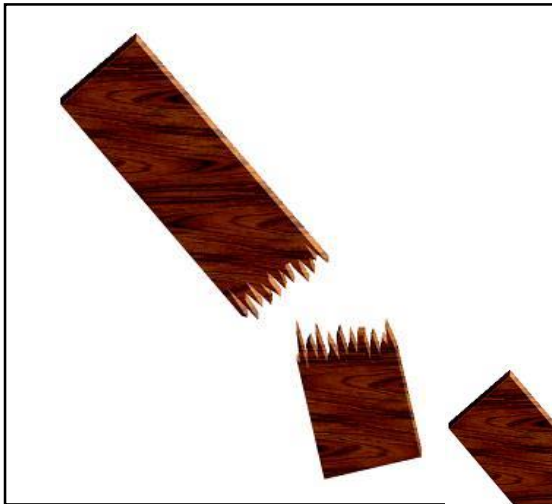
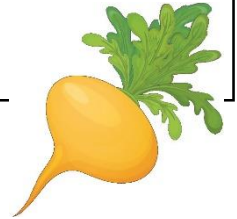

ЩЕПКА

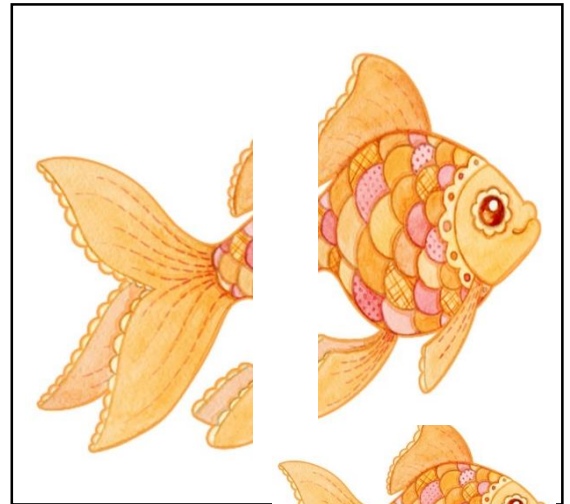

РЫБКА



ЛАПКА

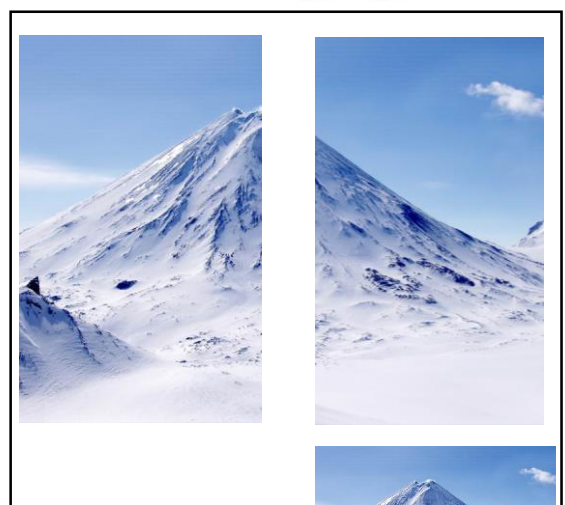

СОПКА

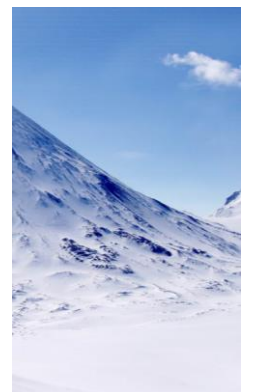

Травкина Ж.А

Сложи слово. 5 класс.

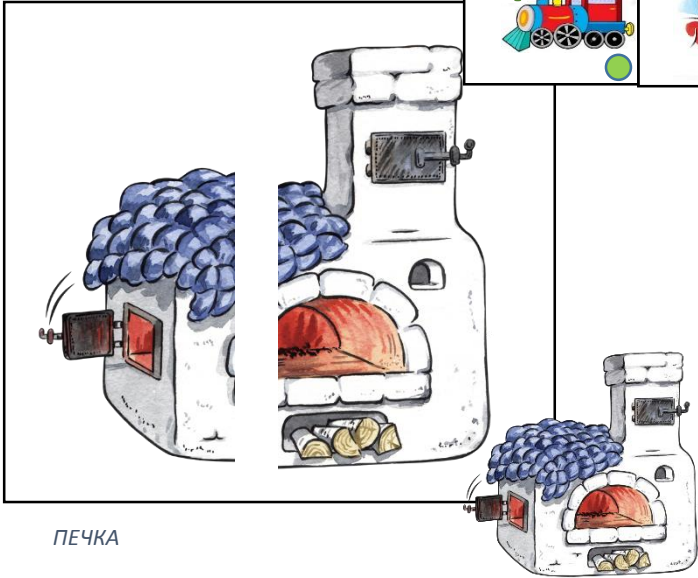

ПЕЧКА



БОЧКА

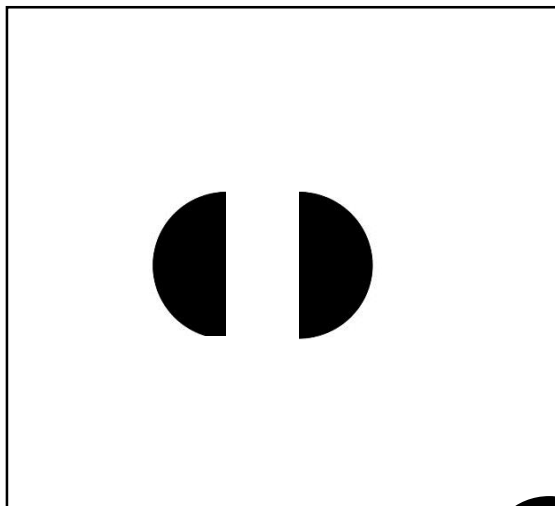

ТОЧКА



ТАЧКА

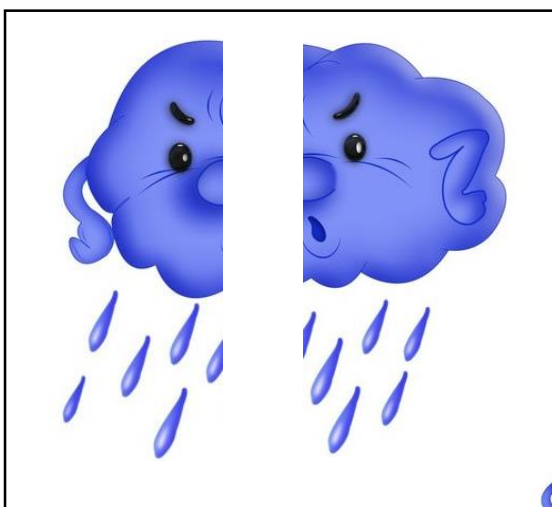

ТУЧКА

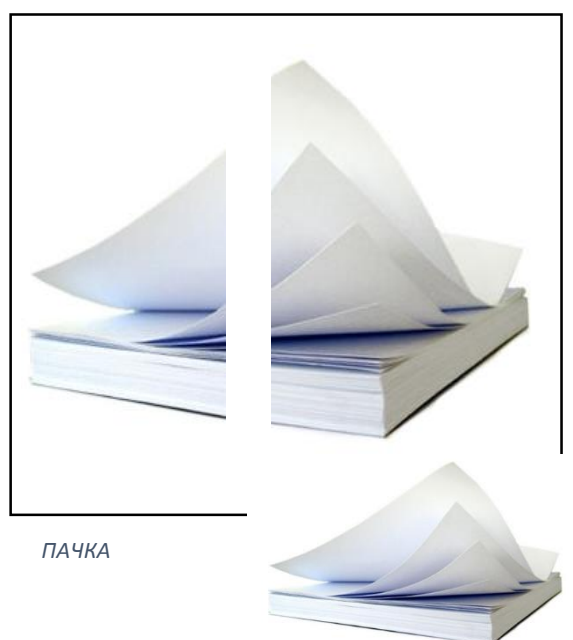

ПАЧКА

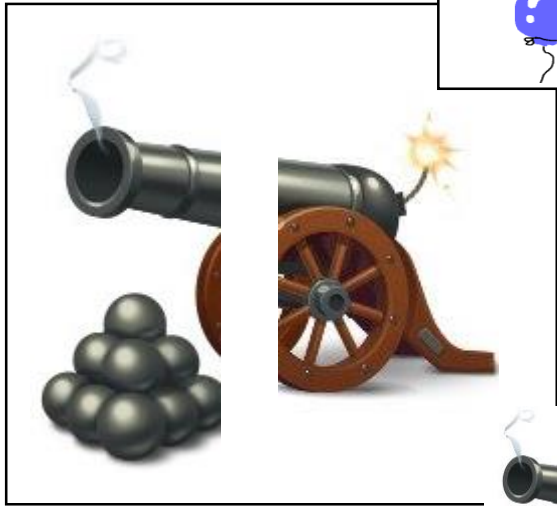

ПУШКА

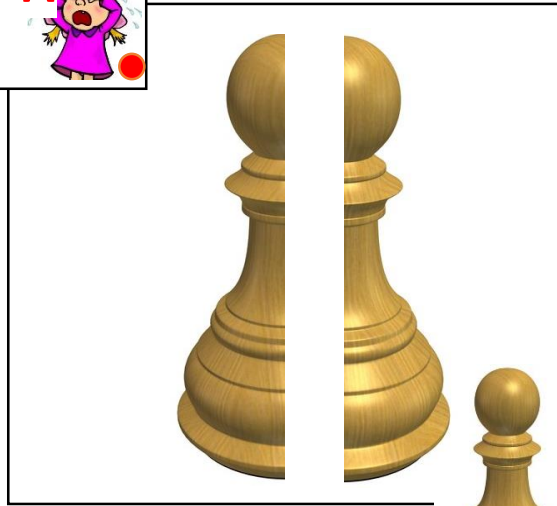

ПЕШКА

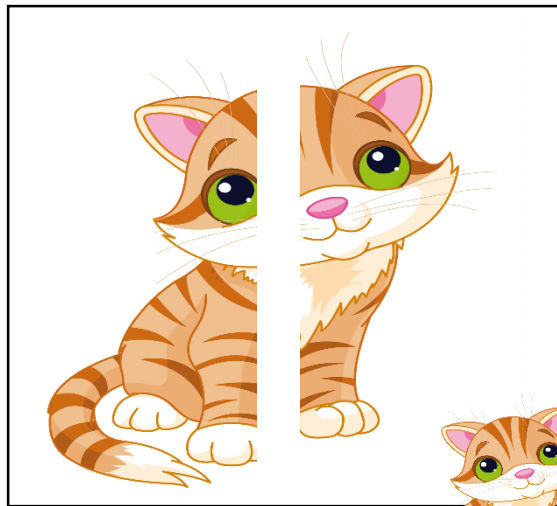

КОШКА

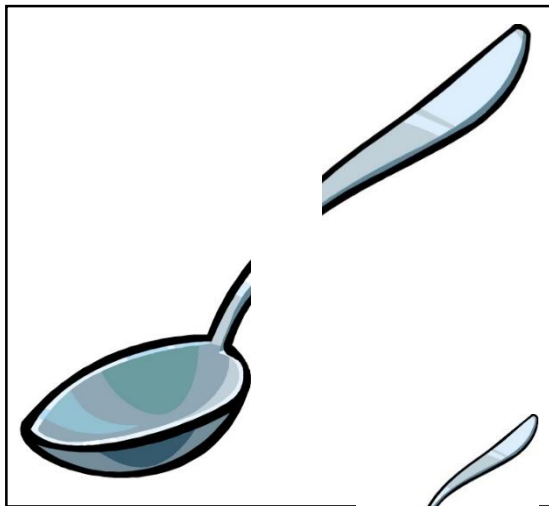

ЛОЖКА

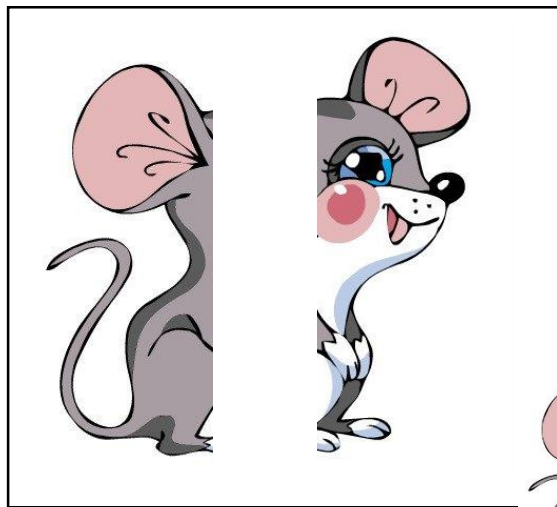

МЫШКА

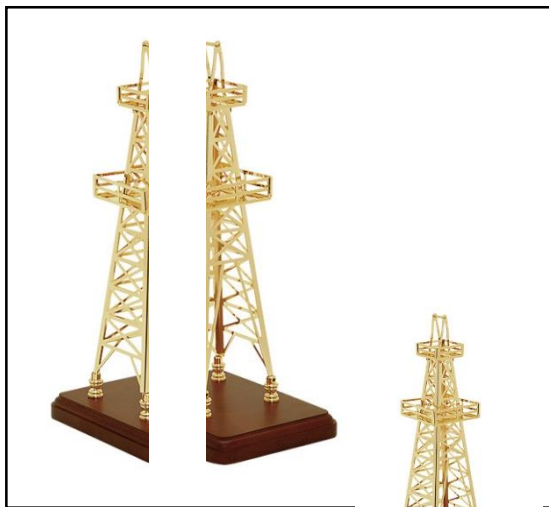

ВЫШКА



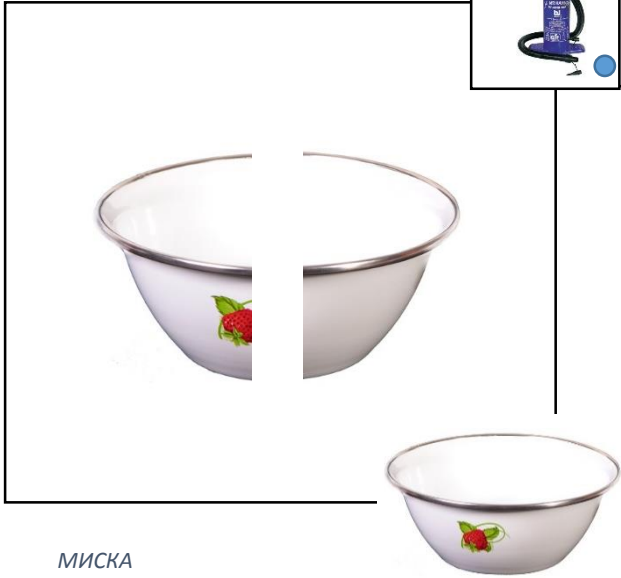

МИСКА

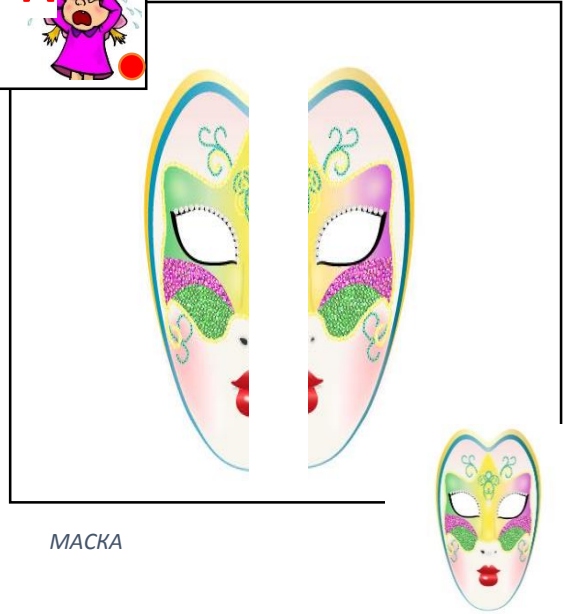

МАСКА

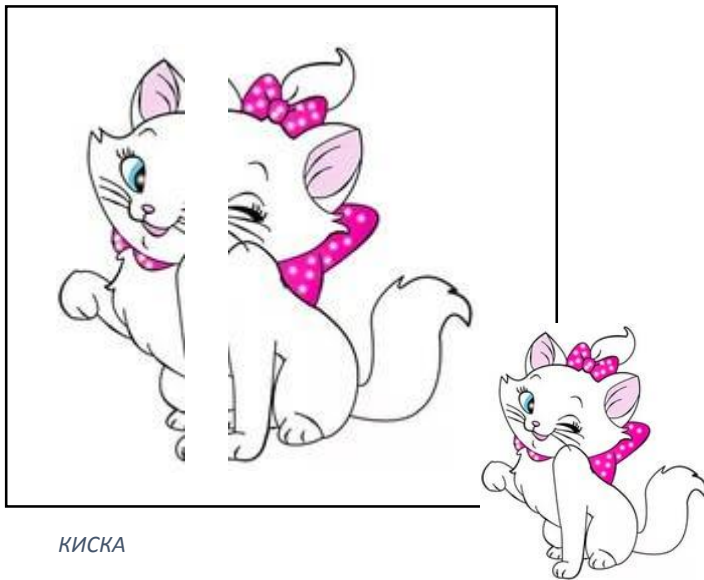

КИСКА

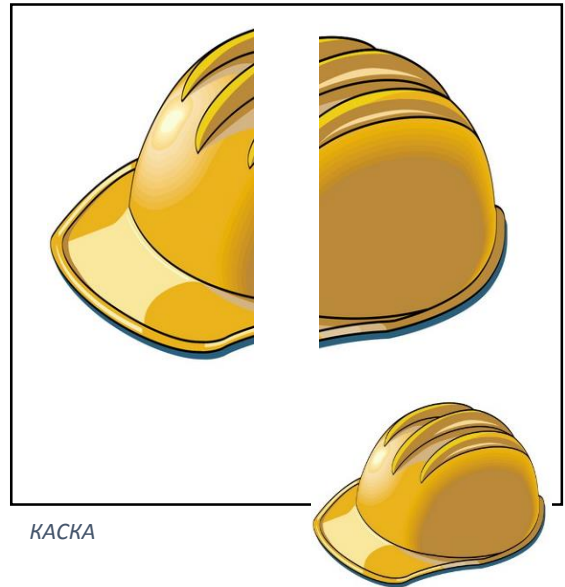

КАСКА



ЛЕСКА

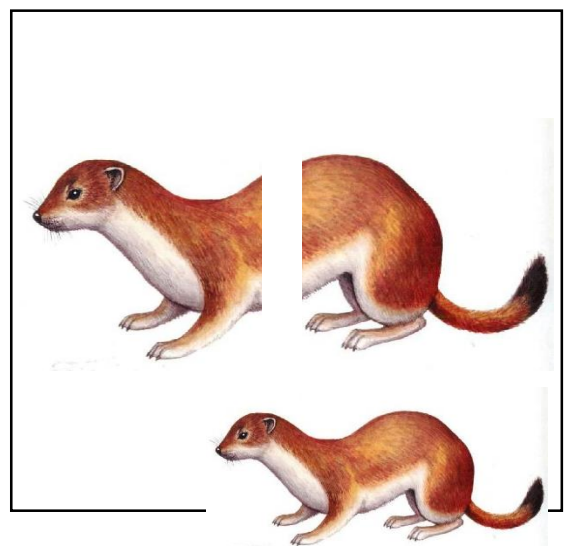

ЛАСКА



СУМКА



РАМКА

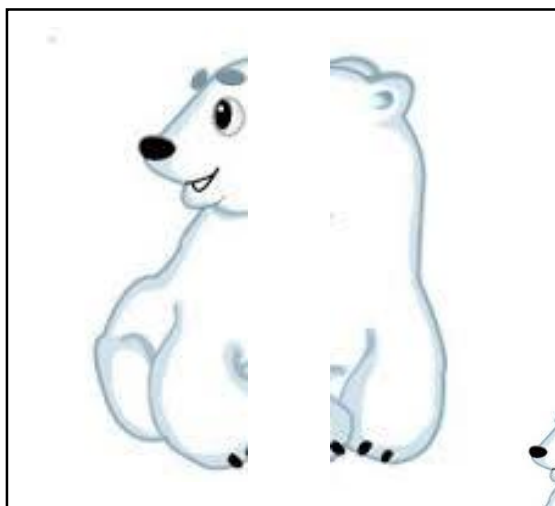

УМКА



ЯМКА

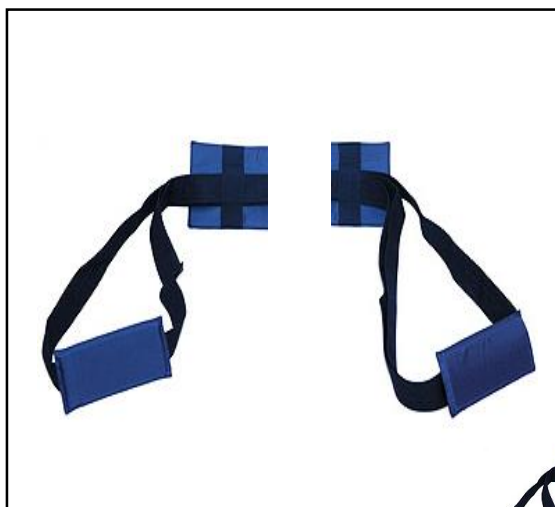

ЛЯМКА



РЮМКА



Травкина Ж.А

Сложи слово. 5 класс.

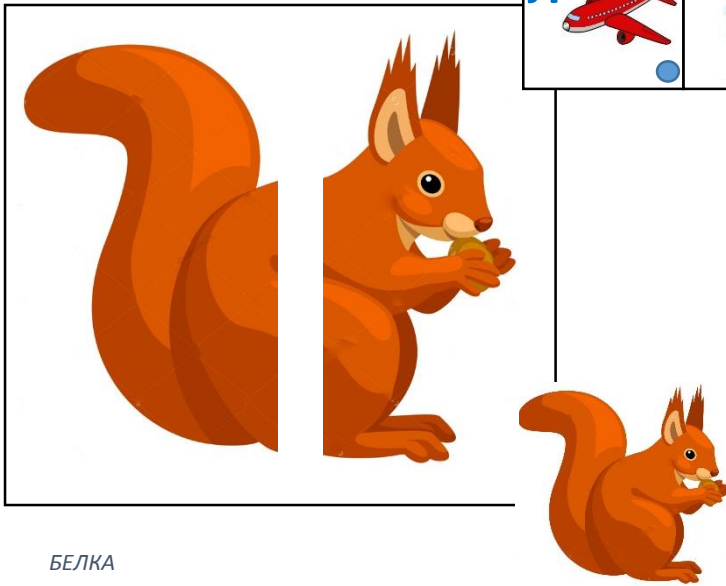

БЕЛКА



ПИЛКА



ВИЛКА

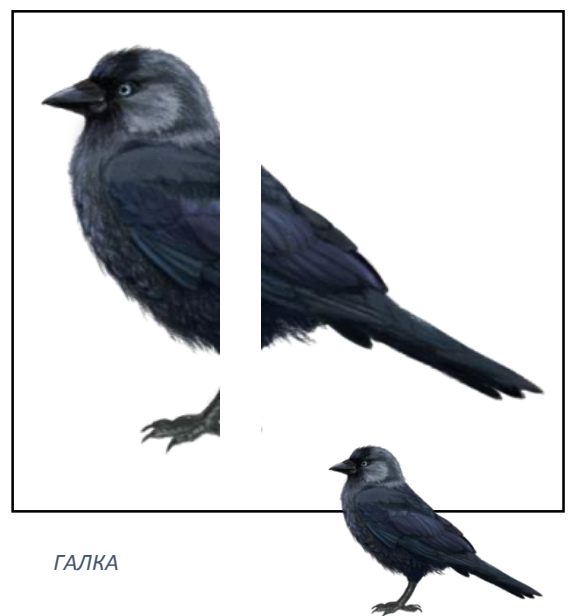

ГАЛКА



БУЛКА

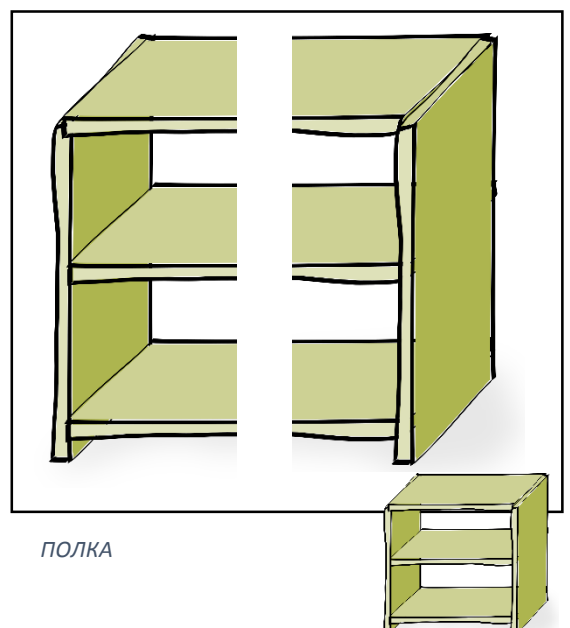

ПОЛКА

Травкина Ж.А

Сложи слово. 5 класс.



ЛЕЙКА



ЗАЙКА

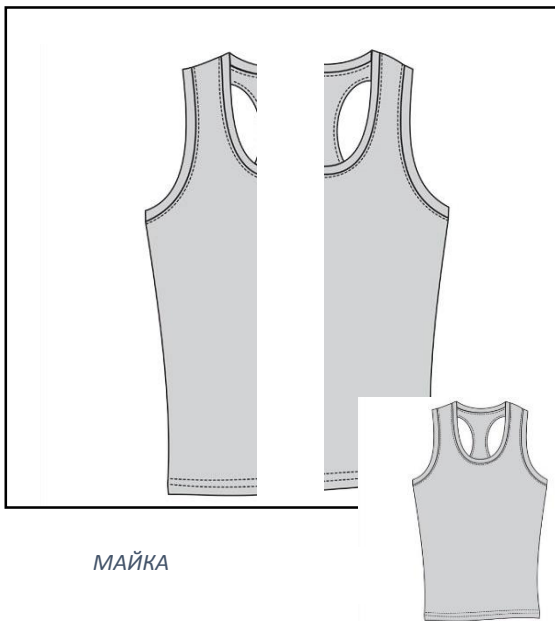

МАЙКА

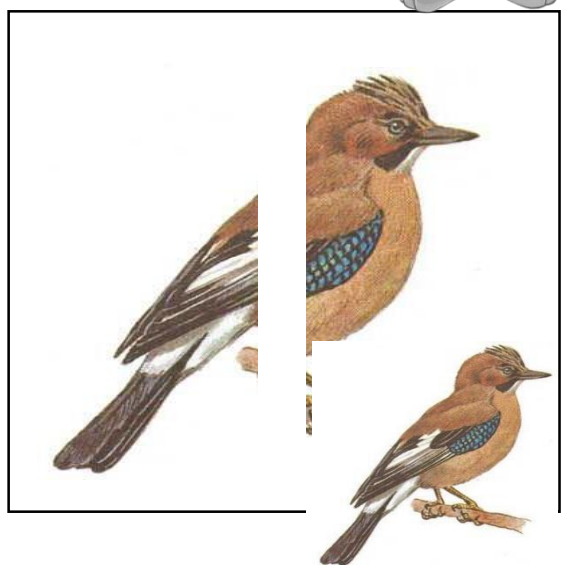

СОЙКА

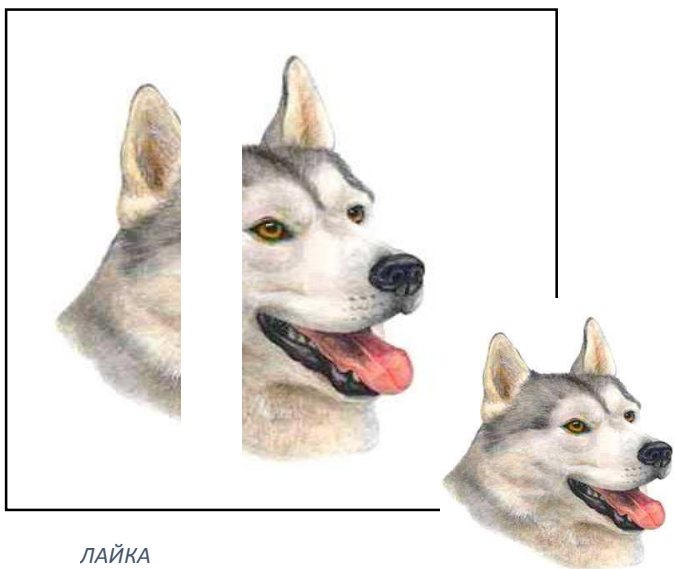

ЛАЙКА



ГАЙКА

Травкина Ж.А

Сложи слово. 5 класс.



БАНКА

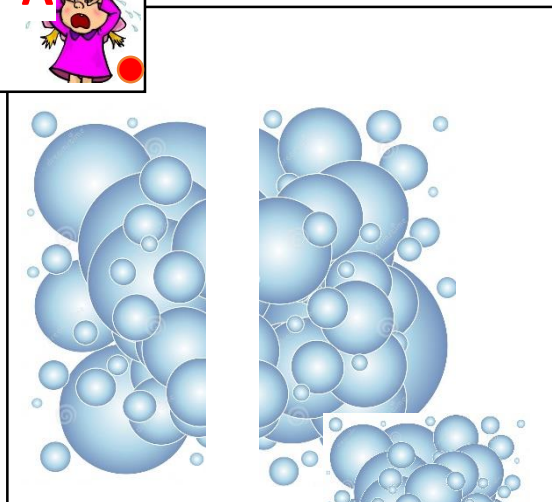

ПЕНКА



ФИНКА

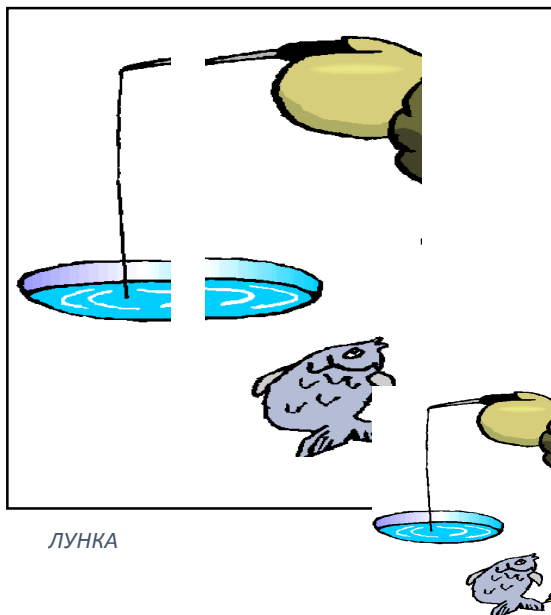

ЛУНКА



МАНКА



РАНКА



Травкина Ж.А

Сложи слово. 5 класс.



ТЫКВА



БУКВА



КОФТА

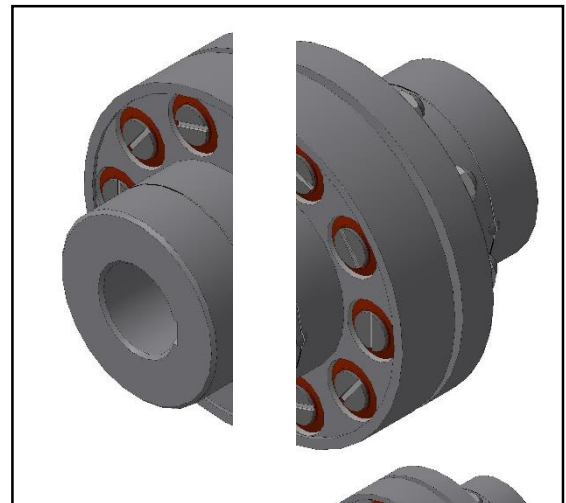

МУФТА

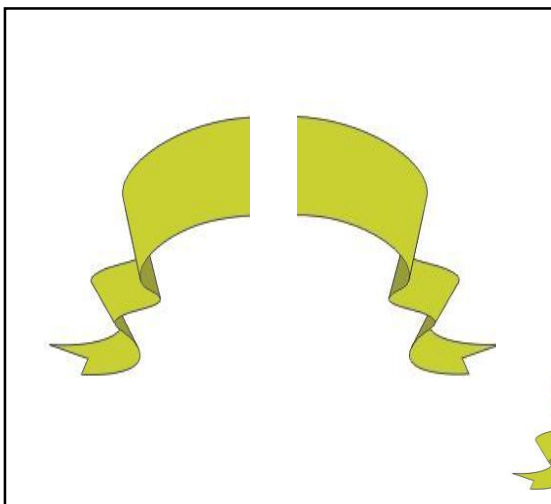

ЛЕНТА



ФАНТА

Травкина Ж.А

Сложи слово. 5 класс.

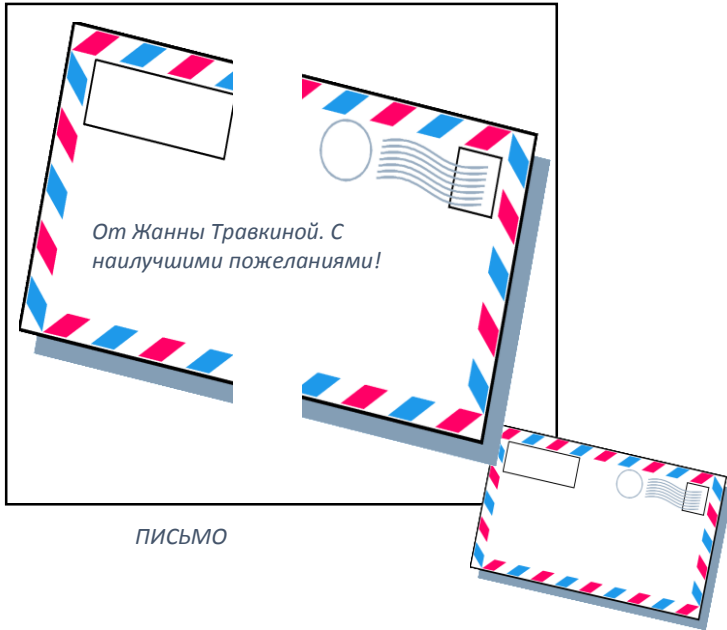

ПИСЬМО

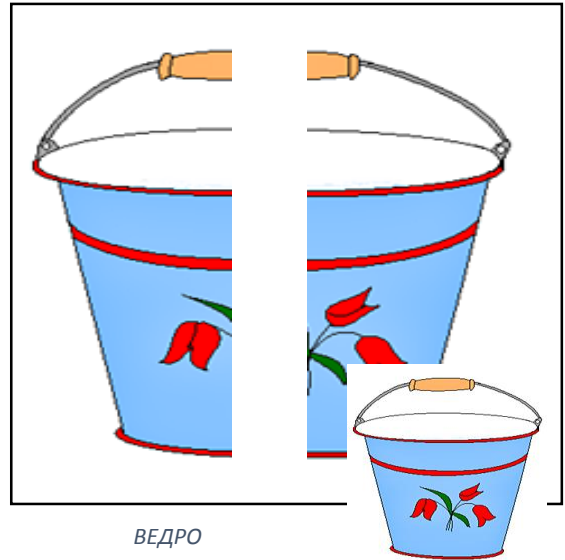

ВЕДРО



ПАЛЬТО

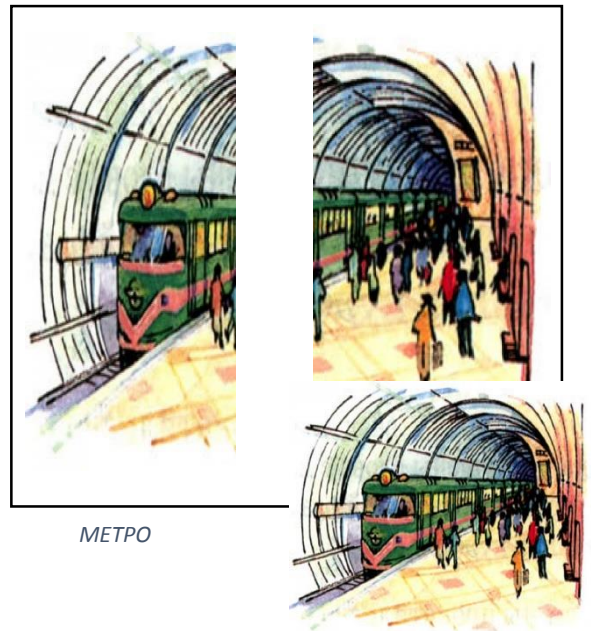

МЕТРО



ОЧКИ

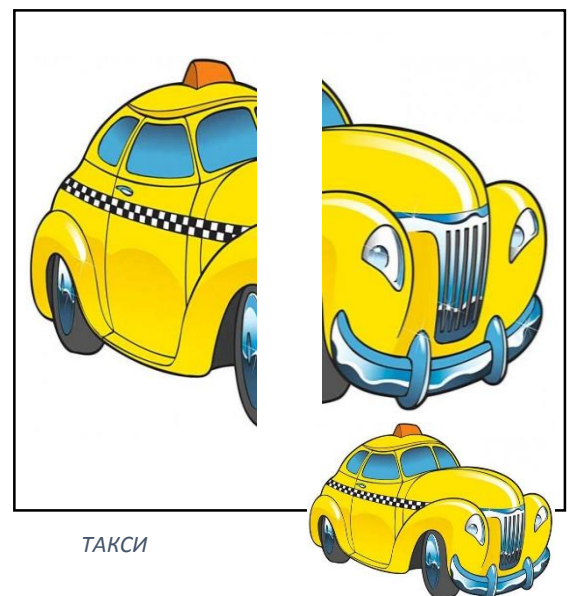

ТАКСИ

Травкина Ж.А

Сложи слово. 6 класс.



ЧАЙНИК

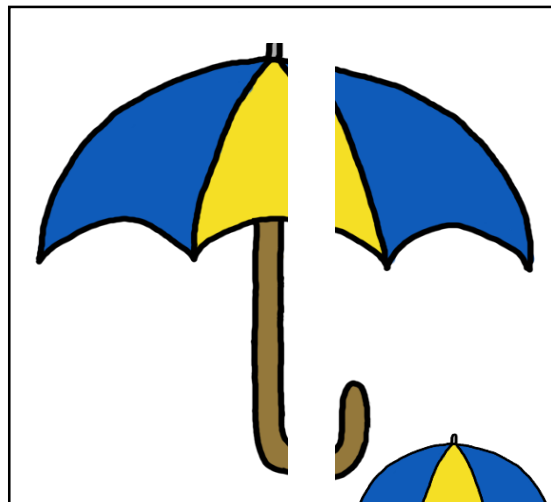

ЗОНТИК

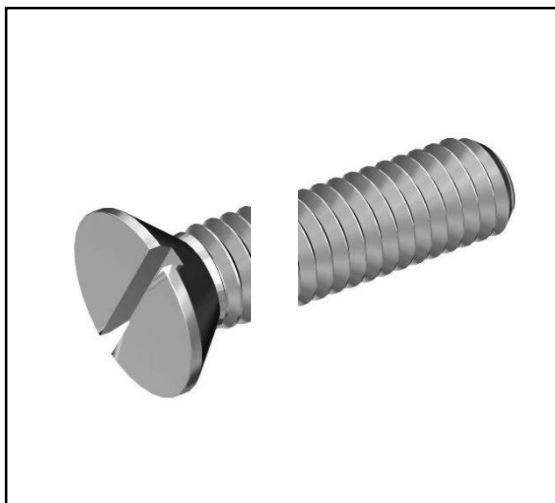

ВИНТИК



БАНТИК

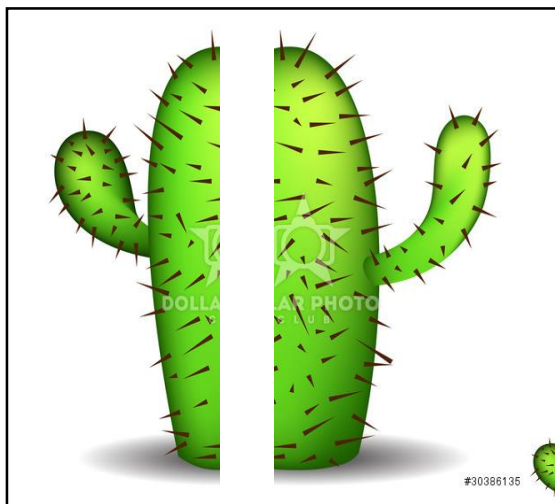

КАКТУС

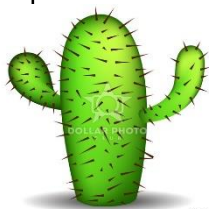

КОМПАС



Травкина Ж.А

Сложи слово 6 класс.

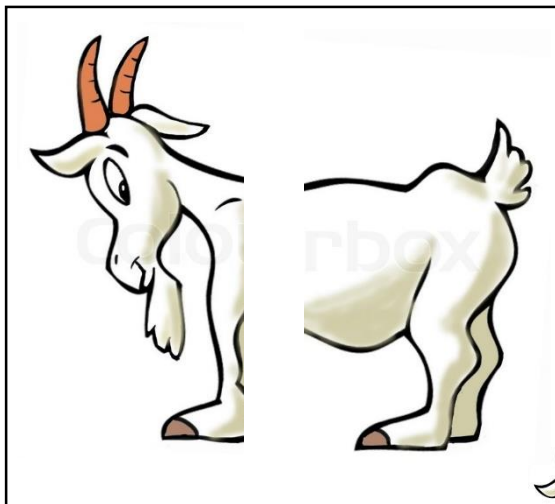

КОЗЛИК

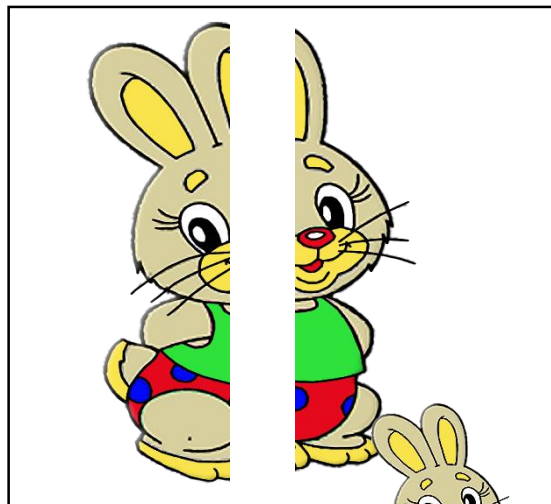

ЗАЙЧИК



ЛАСТИК

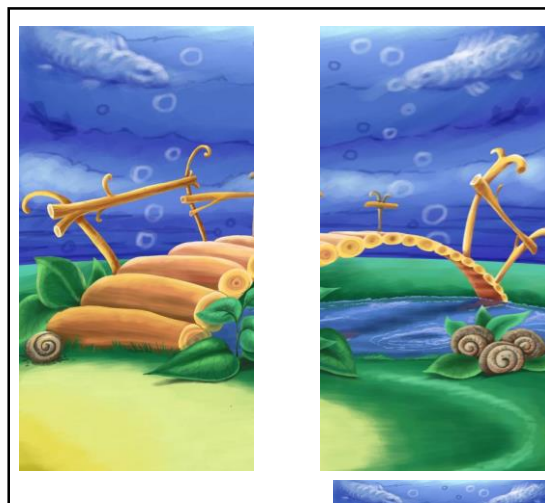

МОСТИК

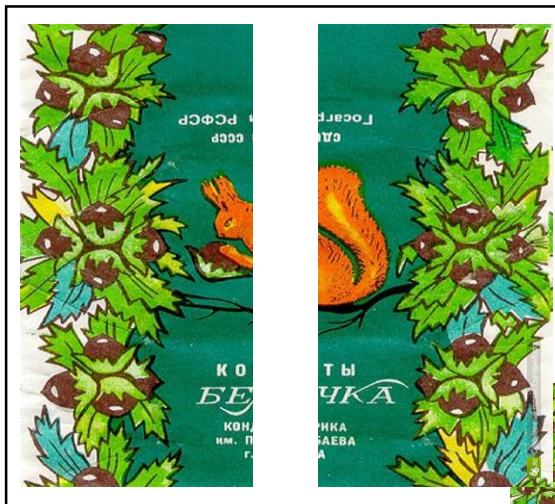

ФАНИК

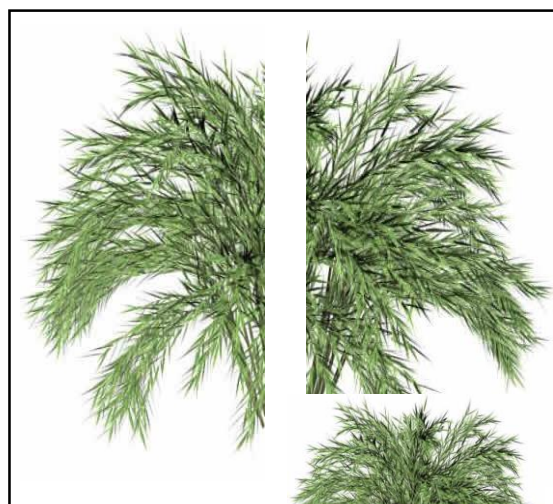

КУСТИК



Травкина Ж.А

Сложи слово 6 класс.

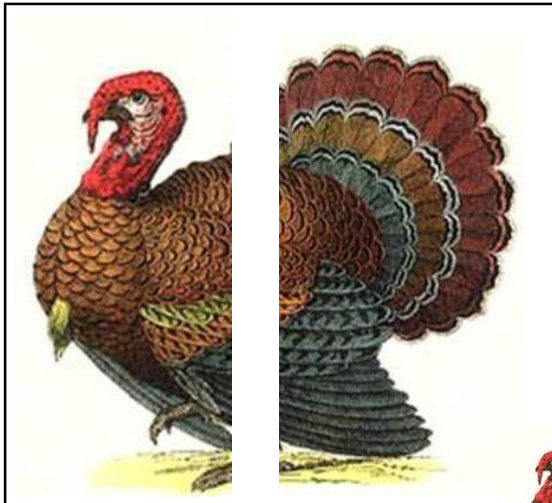

ИНДЮК

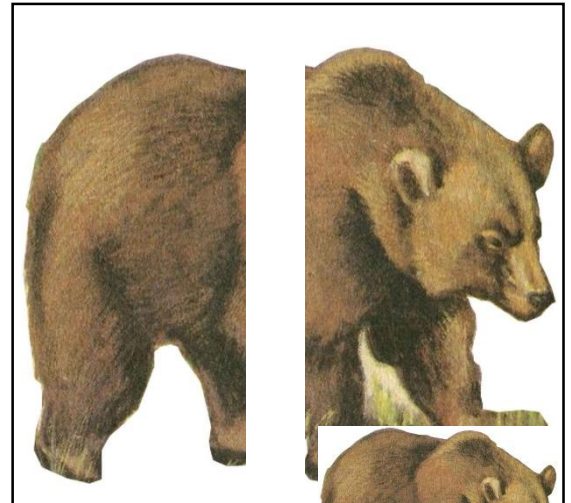

МЕДВЕДЬ

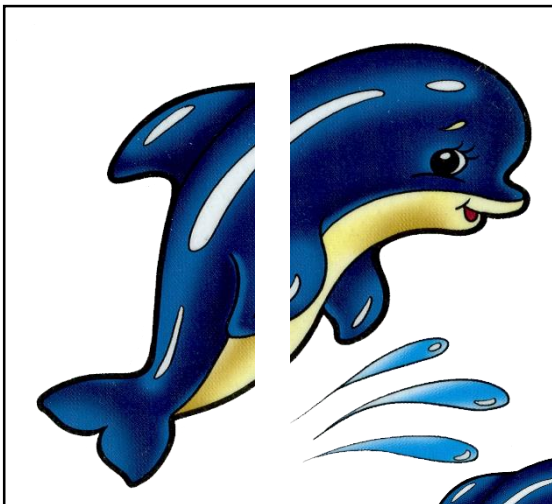

ДЕЛЬФИН

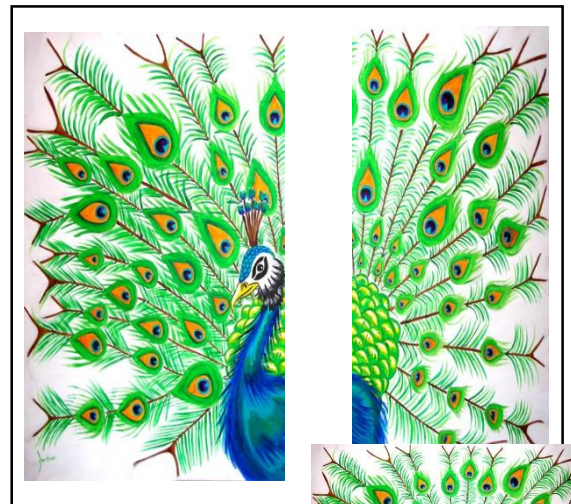
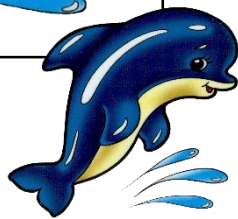

ПАВЛИН

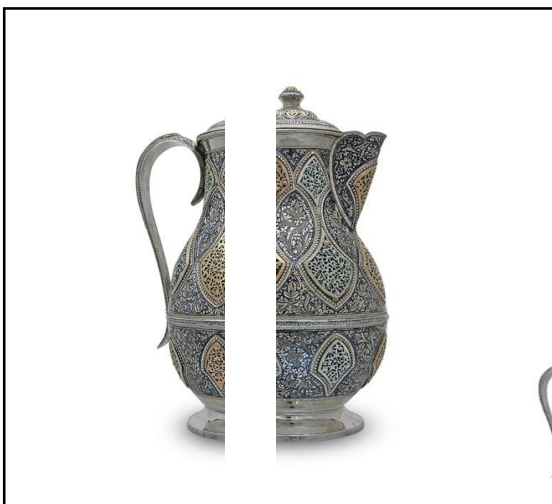
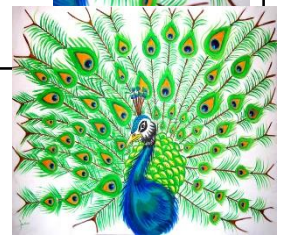

КУВШИН



КОМПОТ



Травкина Ж.А

Сложи слово 6 класс.



ТЮЛЬПАН

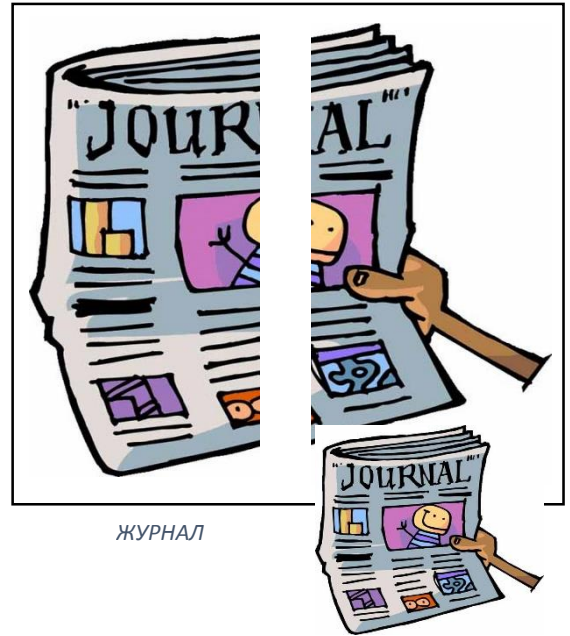

ЖУРНАЛ

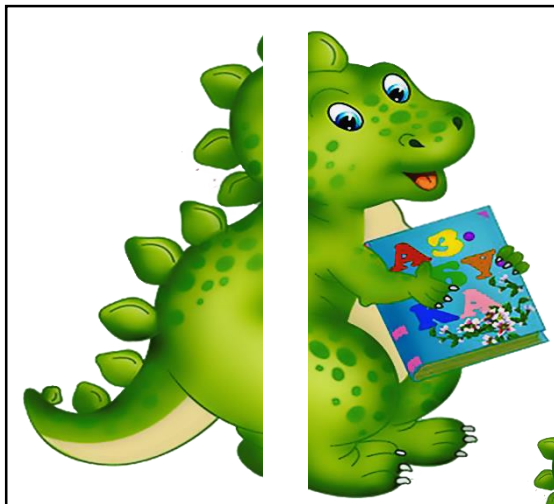

ДРАКОН

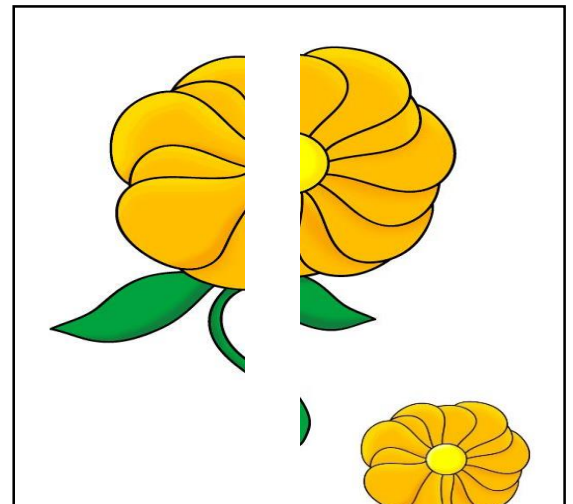

ЦВЕТОК

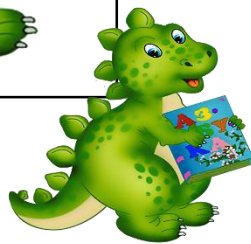

ПЛАТОК

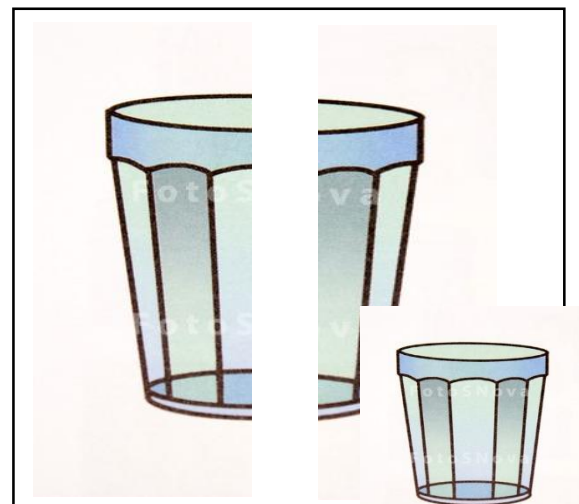

СТАКАН

Травкина Ж.А

Сложи слово 7 класс.

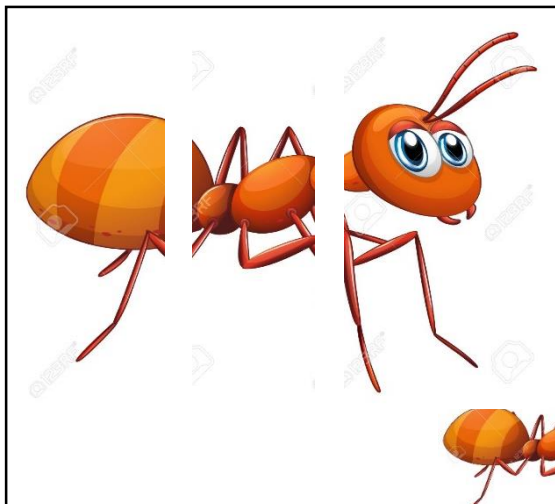

МУРАВЕЙ

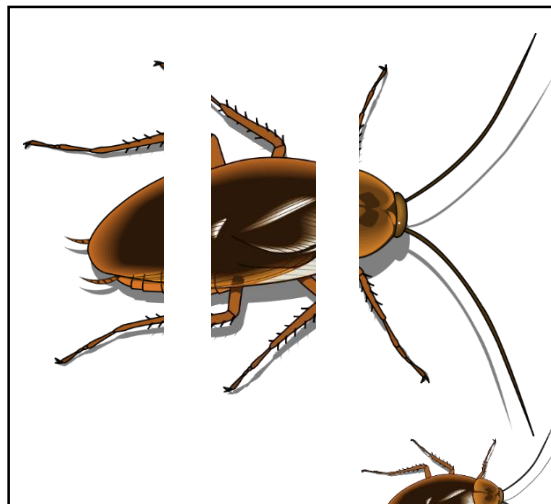
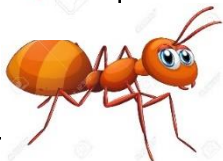

ТАРАКАН

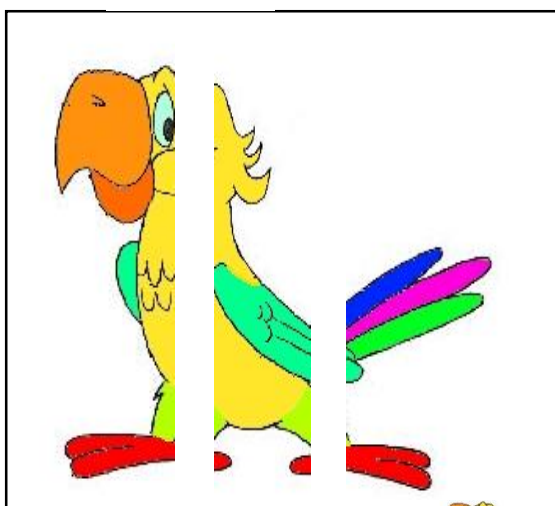

ПОПУГАЙ

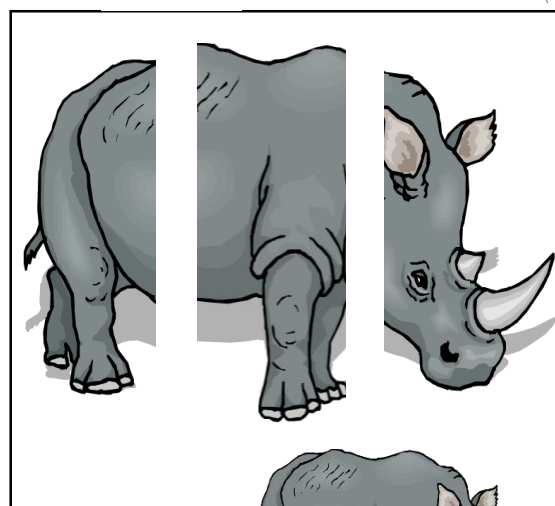

НОСОРОГ

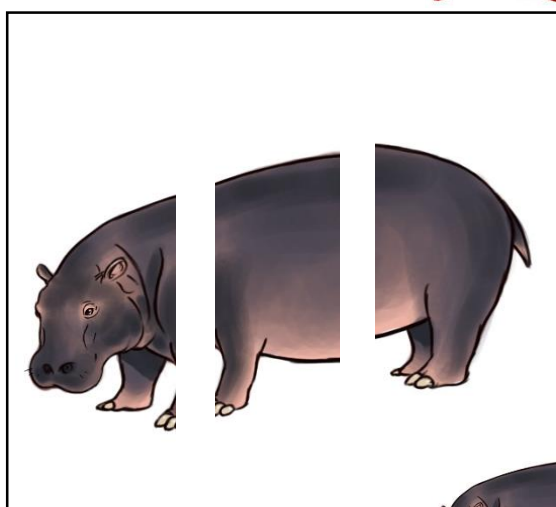
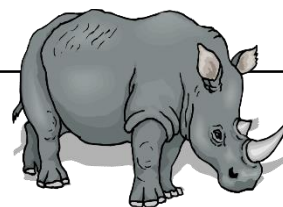

БЕГЕМОТ

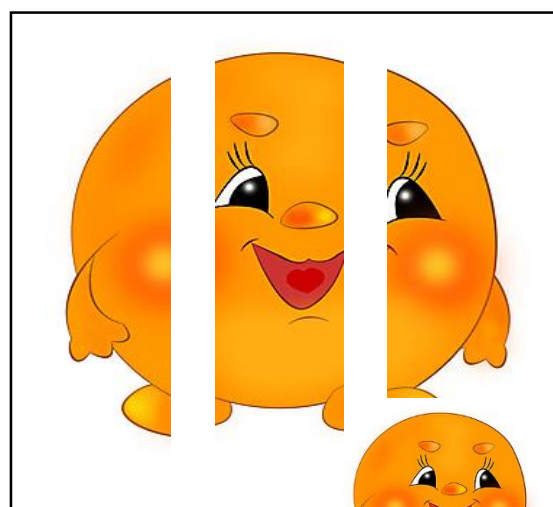

КОЛОБОК



Травкина Ж.А

Сложи слово 7 класс.



ЧЕМОДАН



ПЫЛЕСОС

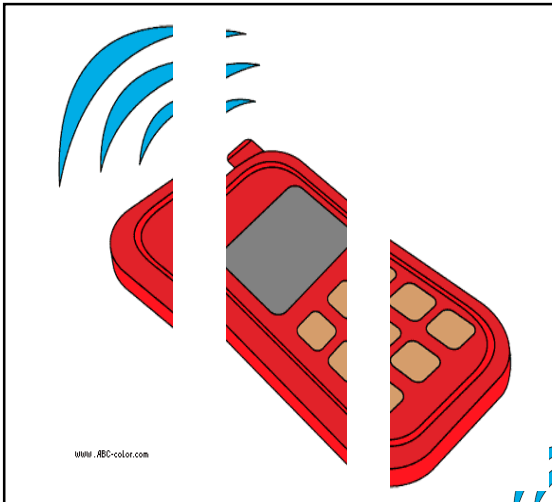

ТЕЛЕФОН

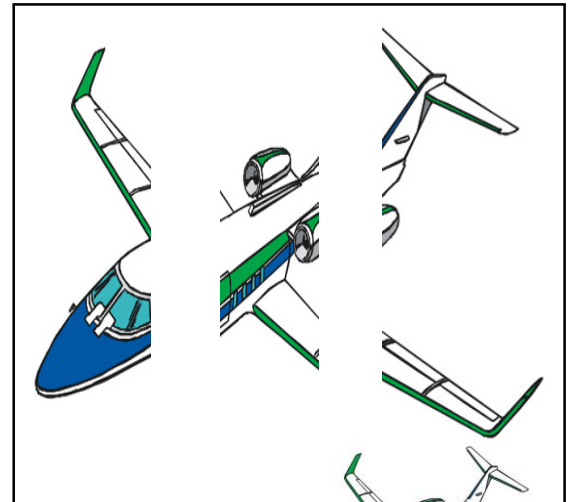

САМОЛЕТ



САМОКАТ



САМОВАР





Травкина Ж.А

Сложи слово 7 класс.

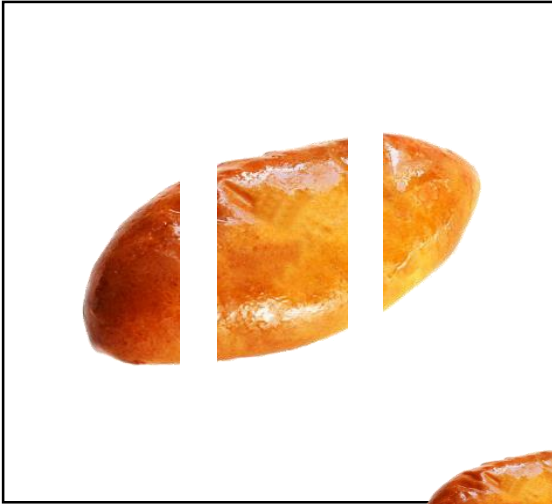

ПИРОЖОК

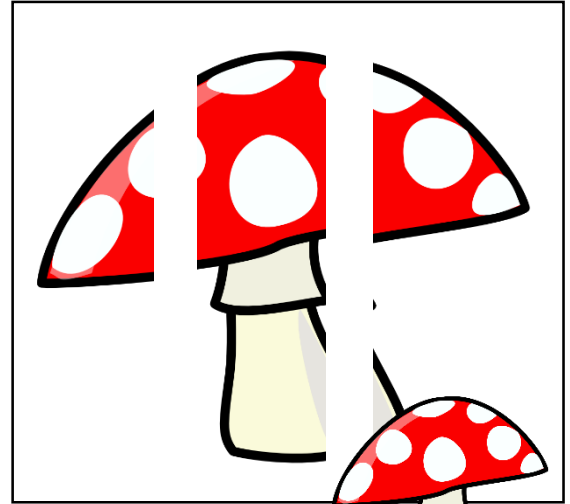

МУХОМОР

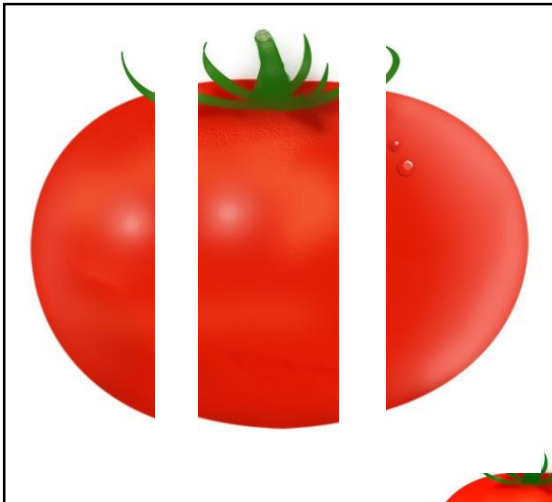

ПОМИДОР

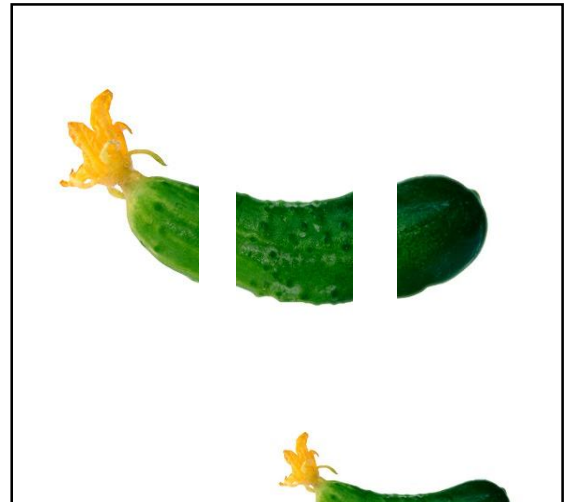

ОГУРЕЦ

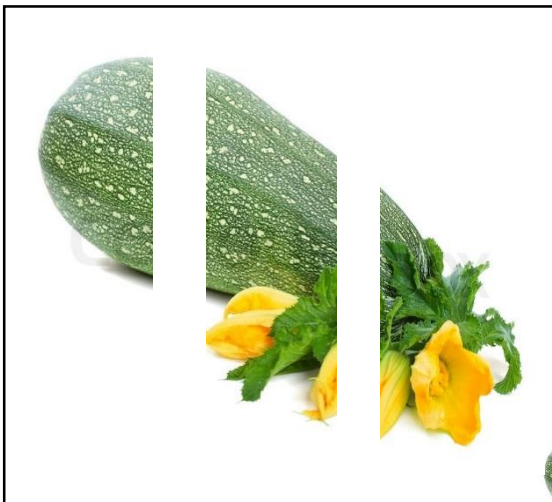

КАБАЧОК

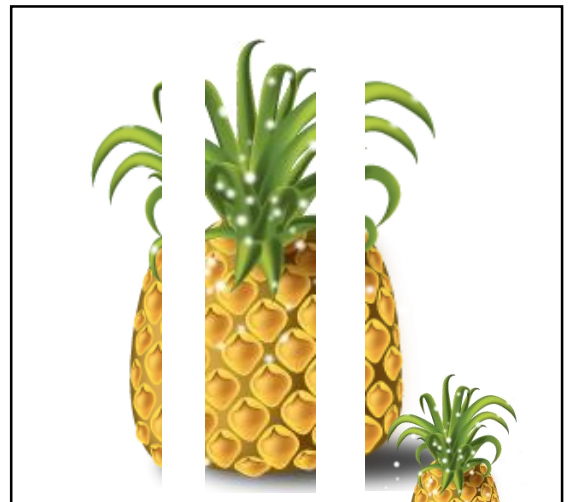

АНАНАС



Травкина Ж.А

Сложи слово 8 класс.

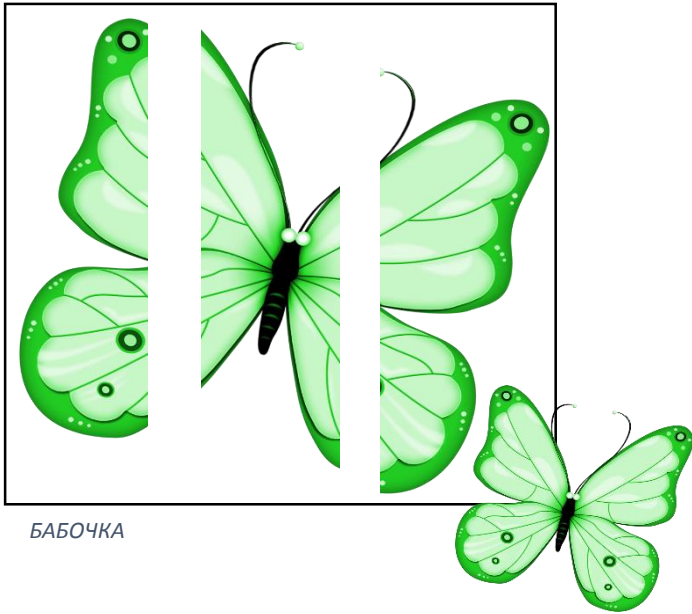

БАБОЧКА

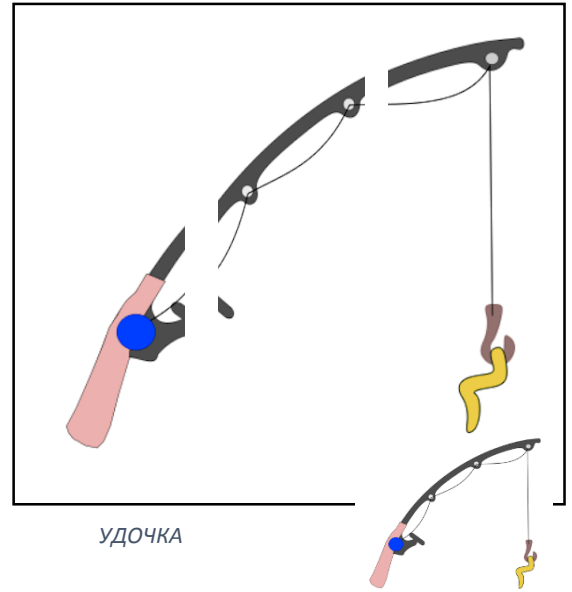

УДОЧКА

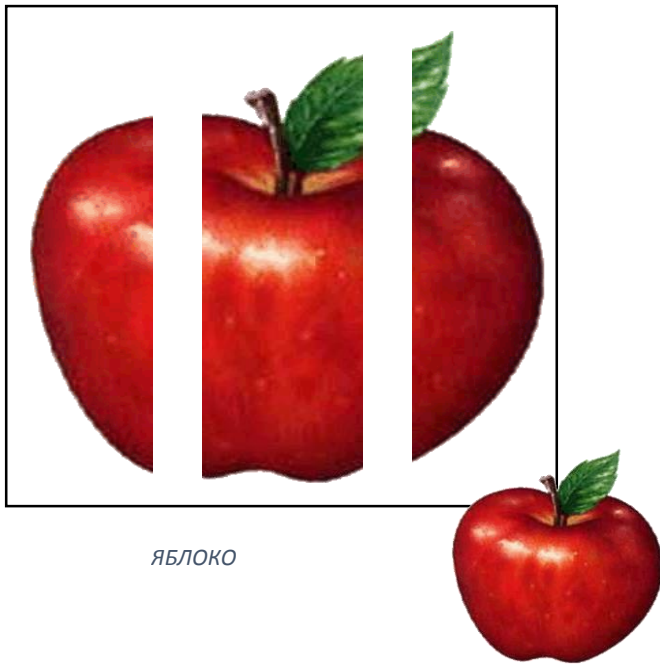

ЯБЛОКО



ШАХМАТЫ



ЛАНДЫШИ



ВАЛЕНКИ

Травкина Ж.А

Сложи слово 8 класс.

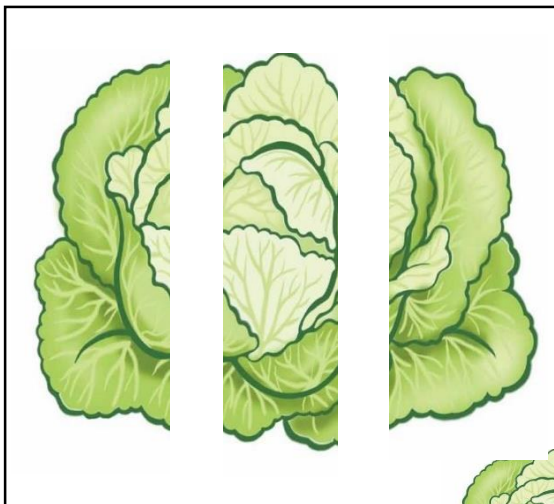

КАПУСТА

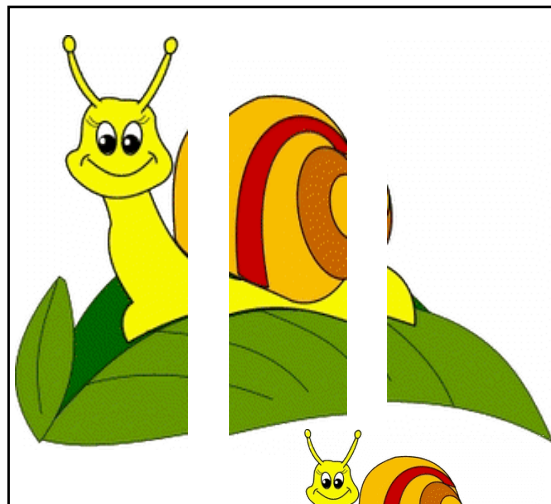

УЛИТКА

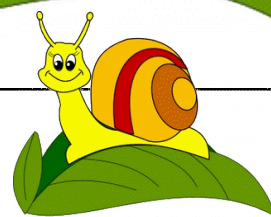

ВЕРЕВКА

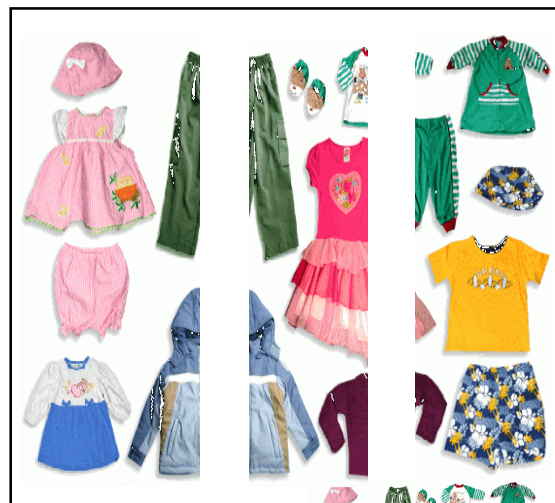

ОДЕЖДА



КОЛЯСКА



ПОДУШКА



Травкина Ж.А

Сложи слово 8 класс.



БЕСЕДКА



ПАЛАТКА



РУБАШКА

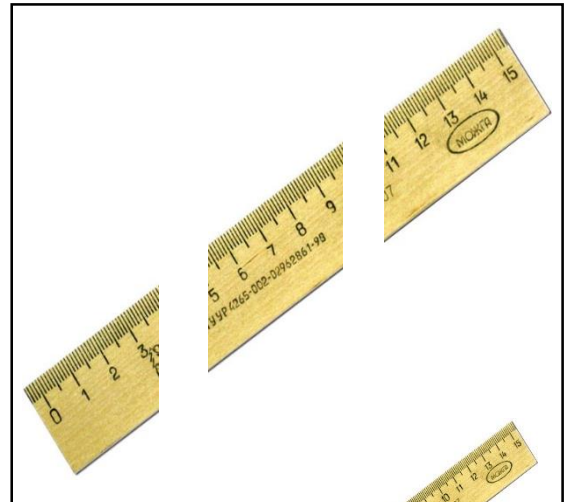

ЛИНЕЙКА

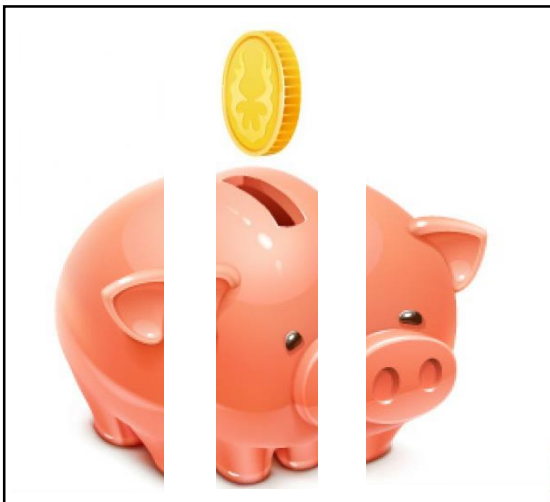

КОПИЛКА

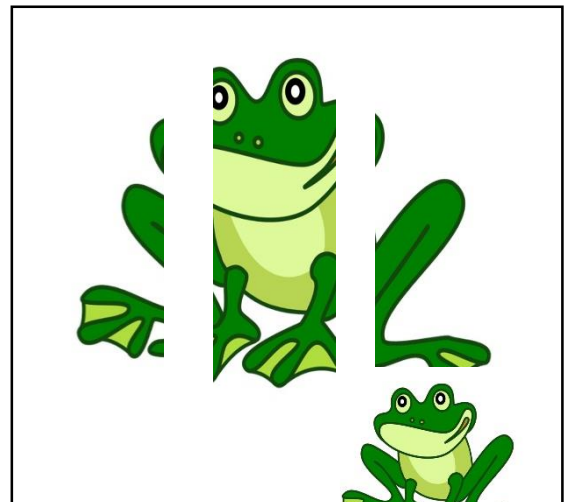

ЛЯГУШКА



Травкина Ж.А

Сложи слово 9 класс.

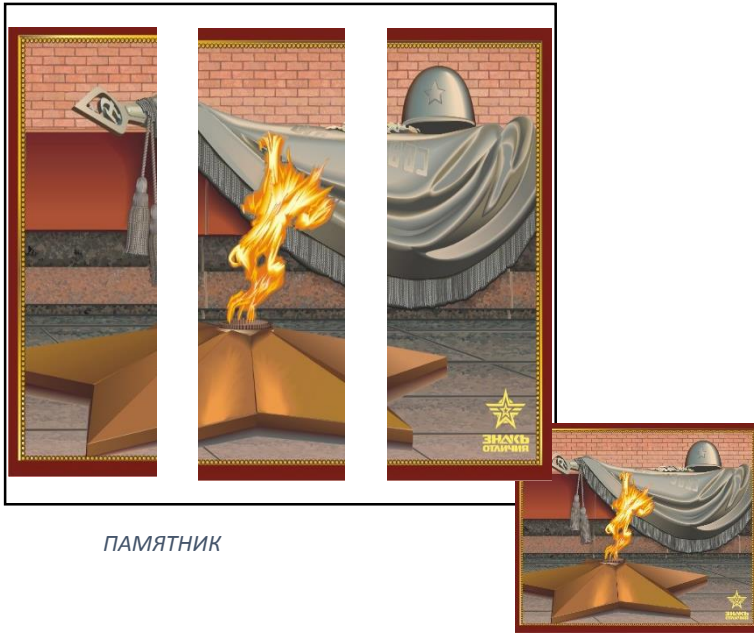

ПАМЯТНИК

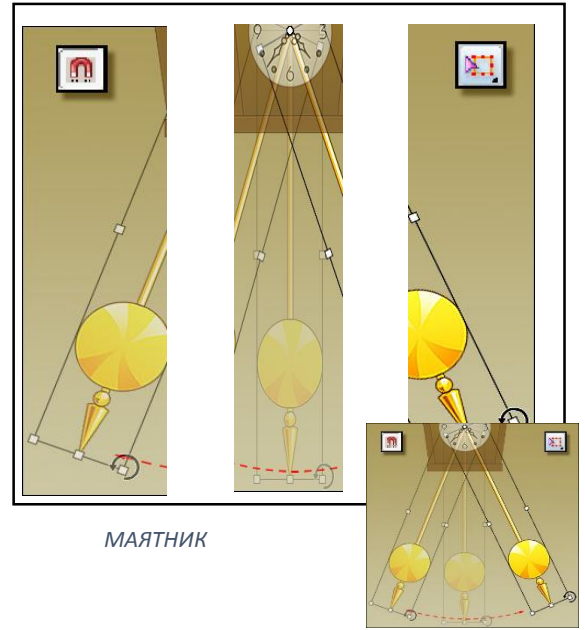

МАЯТНИК

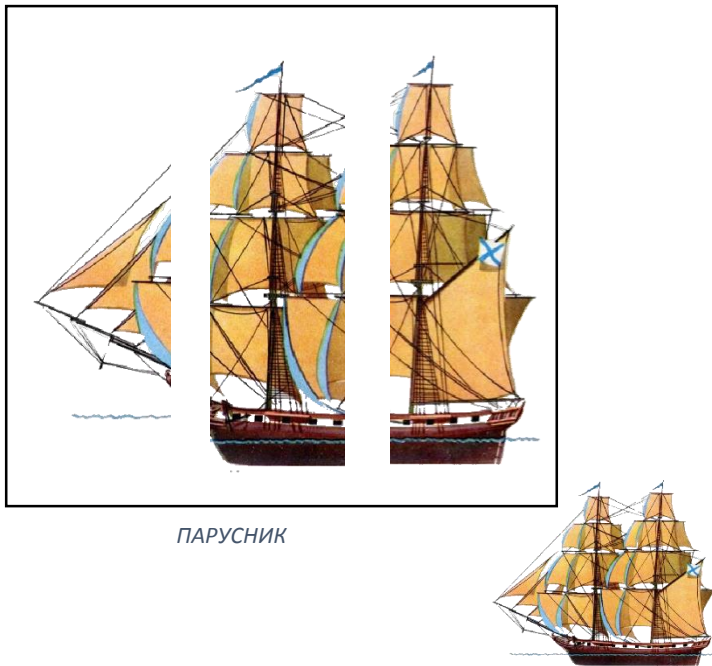

ПАРУСНИК



СОУСНИК

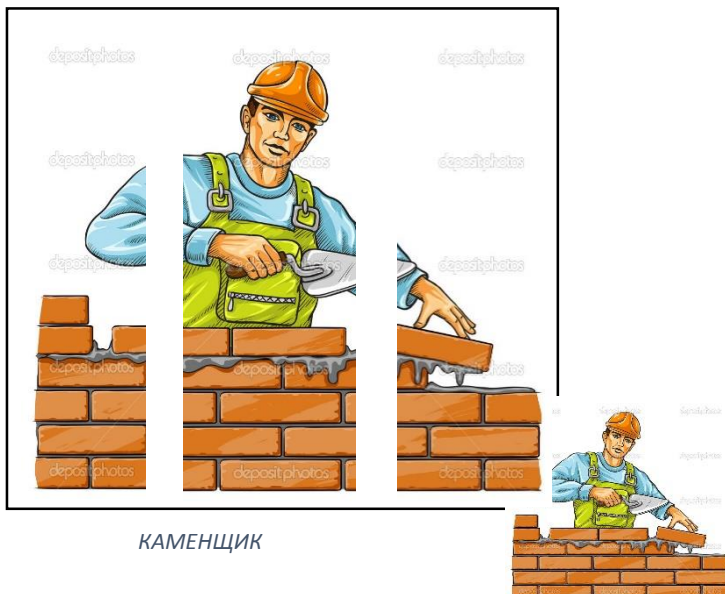

КАМЕНЩИК



ФОКУСНИК

Травкина Ж.А

Сложи слово 9 класс.



КУЗНЕЧИК



ЖУРАВЛИК

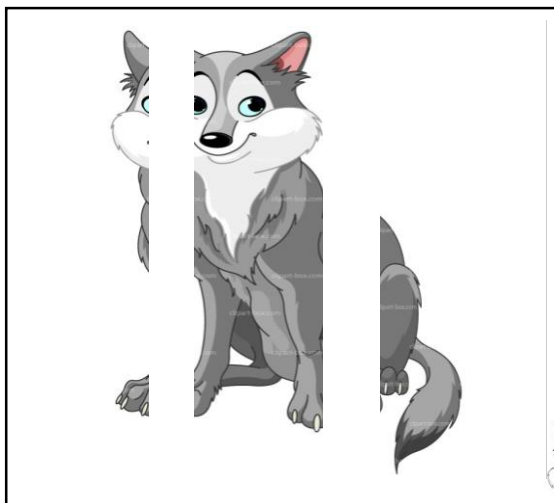

ВОЛЧОНОК

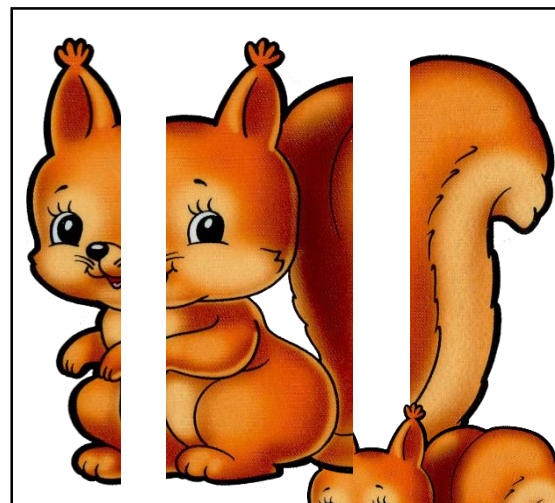

БЕЛЬЧОНОК



ЦЫПЛЕНОК

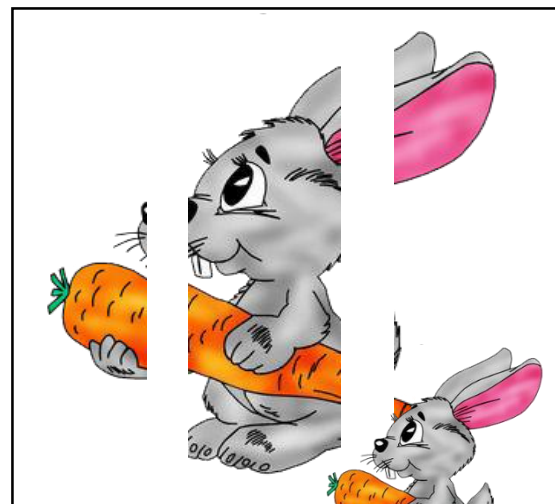

ЗАЙЧОНОК

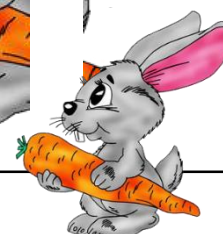

Травкина Ж.А

Сложи слово 9 класс.

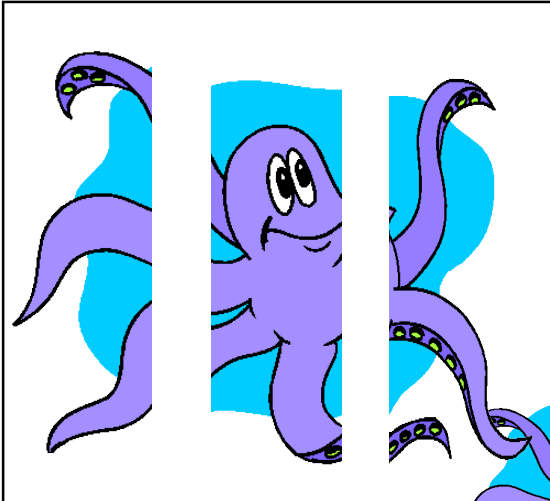

ОСЬМИНОГ



КАРАНДАШ



САМОСВАЛ



ВЕРТОЛЕТ

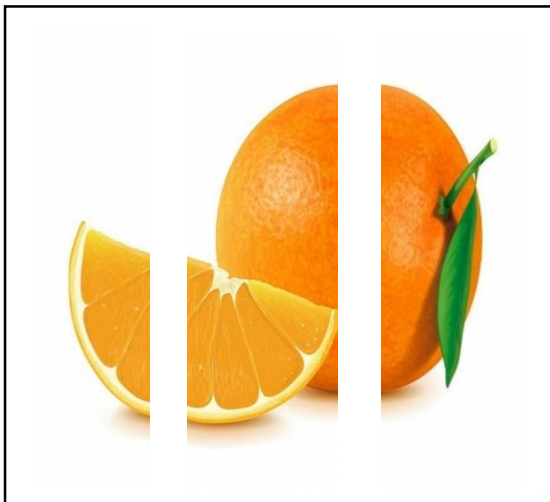

АПЕЛЬСИН

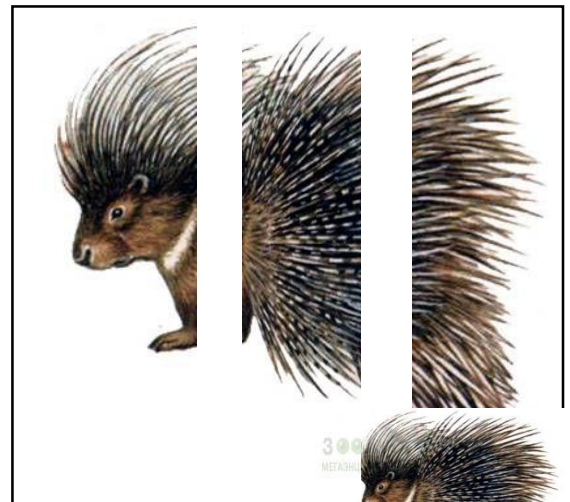

ДИКОБРАЗ

Травкина Ж.А

Сложи слово 10 класс.



КИСТОЧКА



КОСТОЧКА

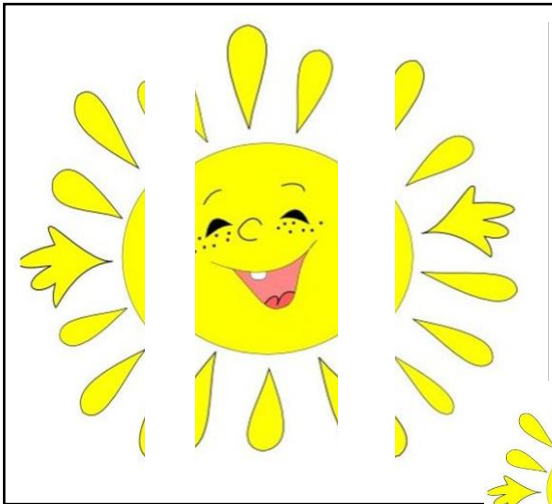

СОЛНЫШКО

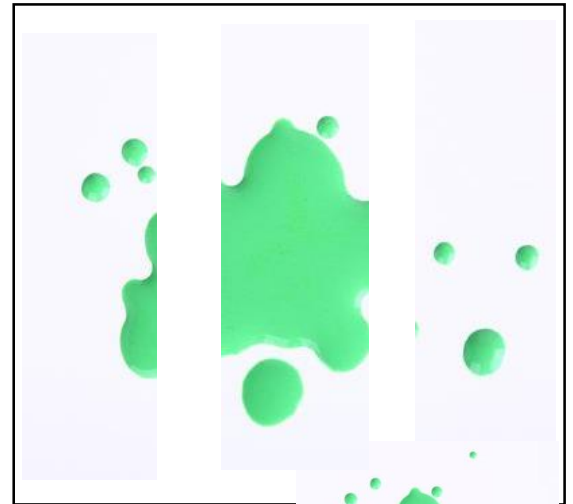

ПЯТНЫШКО



ЗЕРНЫШКИ



КОФТОЧКА





Травкина Ж.А

Сложи слово 10 класс.

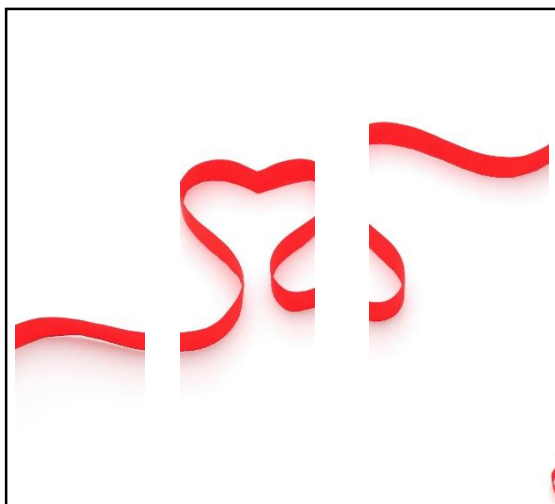

ЛЕНТОЧКА



ЛАСТОЧКА

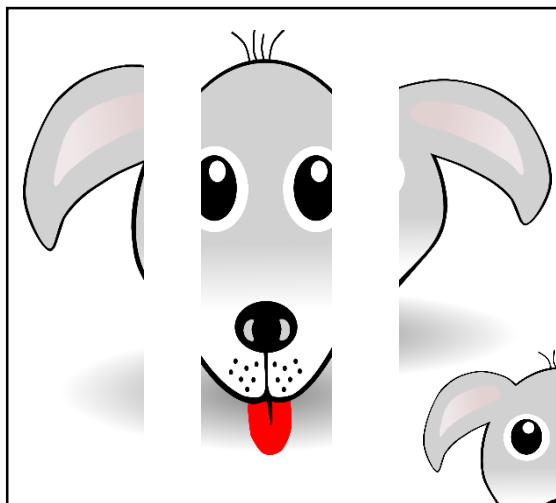

МОРДОЧКА



КУРТОЧКА

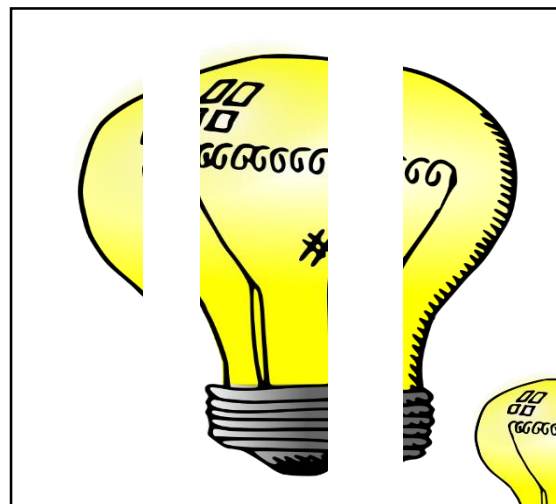

ЛАМПОЧКА



КАРТОЧКА

Травкина Ж.А

Сложи слово 10 класс.

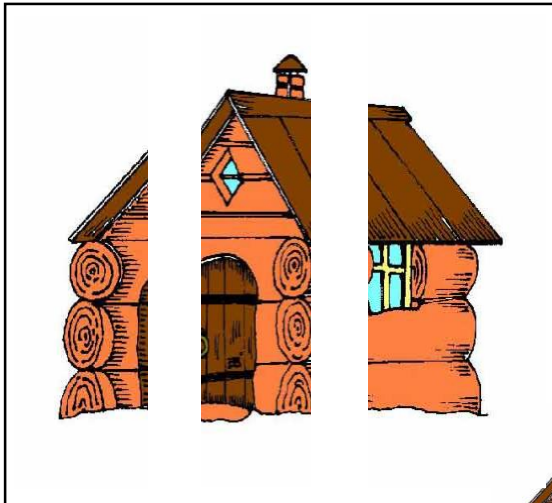

ИЗБУШКА

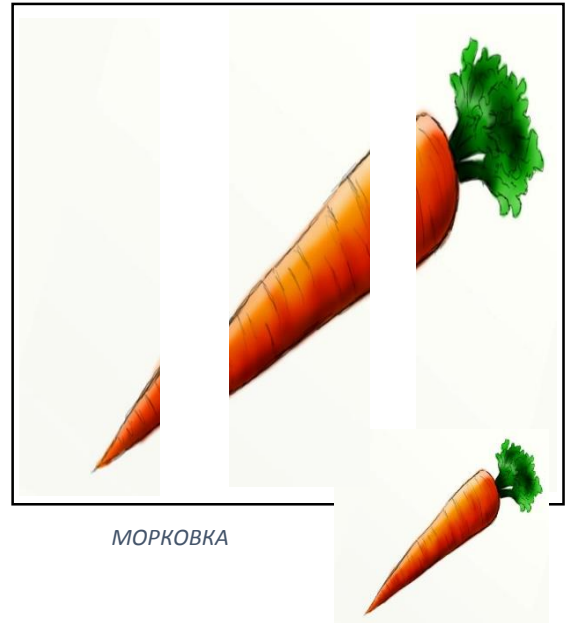

МОРКОВКА



КОРЗИНКА



ТЕТРАДКА

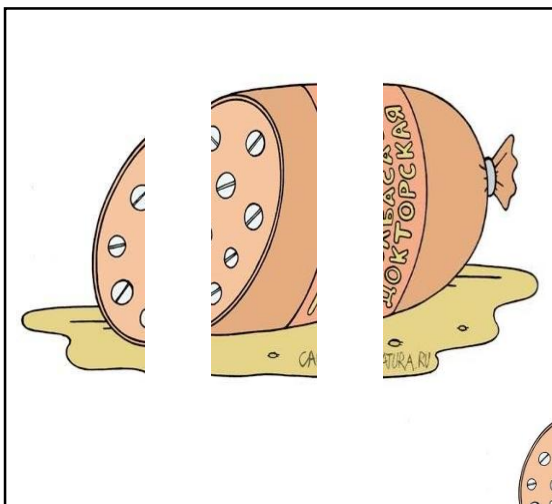

КОЛБАСКА

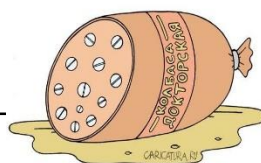

КАРТОШКА

Травкина Ж.А

Сложи слово 10 класс.



МАТРЕШКА



КОРМУШКА

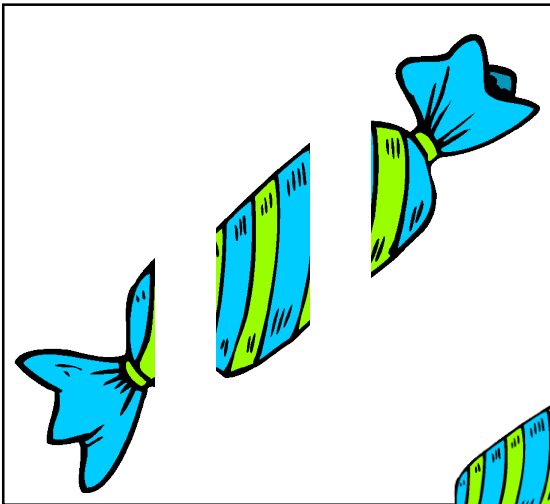

КОНФЕТКА

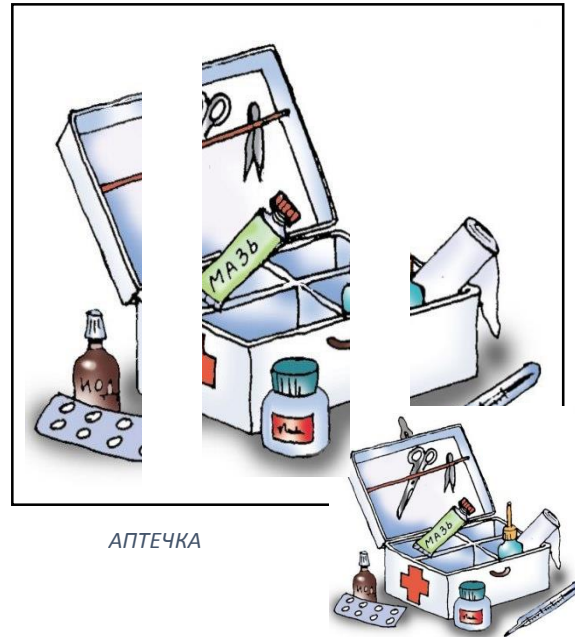

АПТЕЧКА



КОЛГОТКИ



ПОДСОЛНУХ

Травкина Ж.А

Сложи слово 12 класс.



КЛУМБА



КЛЕТКА



КЛЮШКА



СВЁКЛА

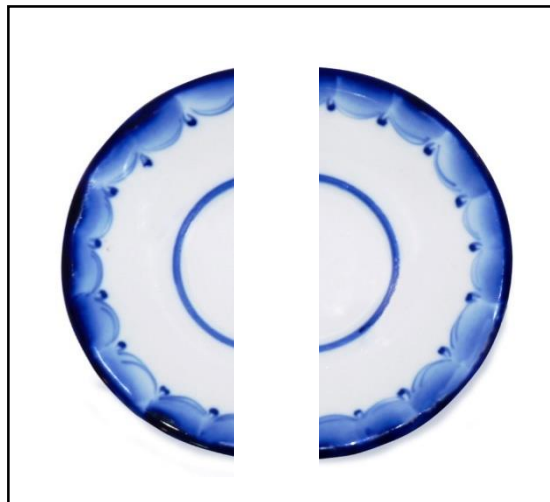

БЛЮДЦЕ



ПЛАТЬЕ



Травкина Ж.А

Сложи слово 13 класс.

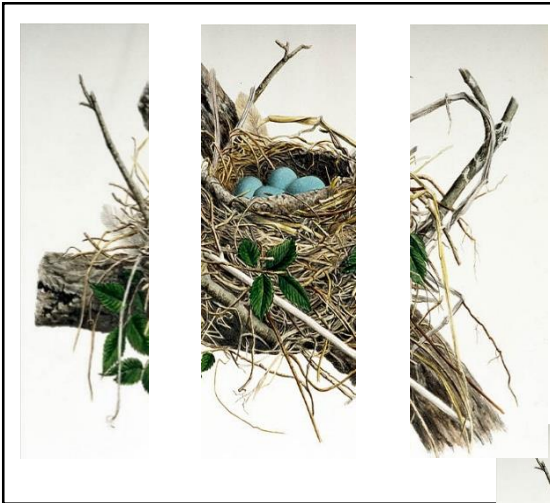

ГНЕЗДЫШКО

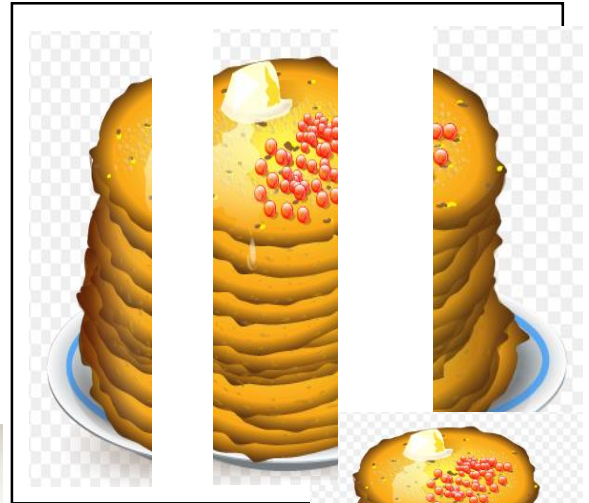

БЛИНЧИКИ



БРЕВНЫШКО



СКАЗОЧКА



БЛЮДЕЧКО

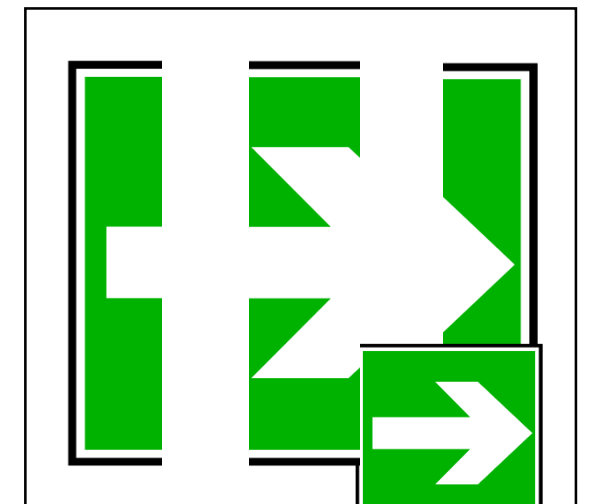

СТРЕЛОЧКА

Травкина Ж.А.

Сложи слово 13 класс.



ШКАТУЛКА



СКАМЕЙКА

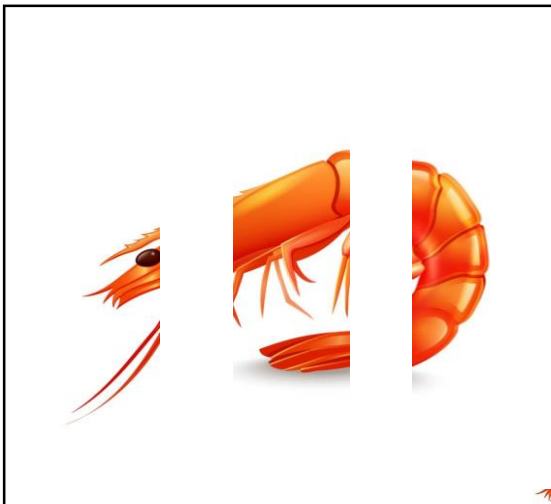

КРЕВЕТКА

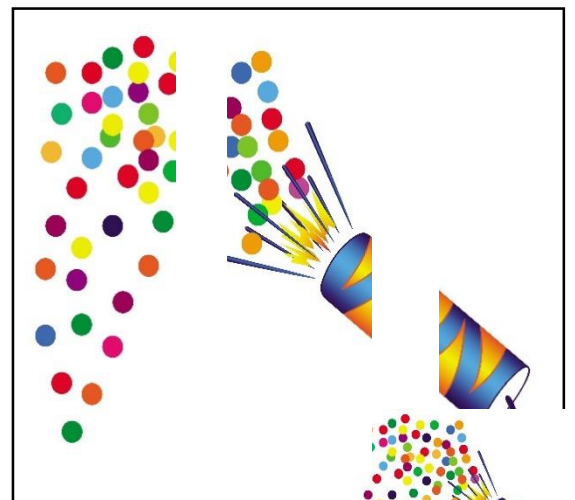

ХЛОПУШКА

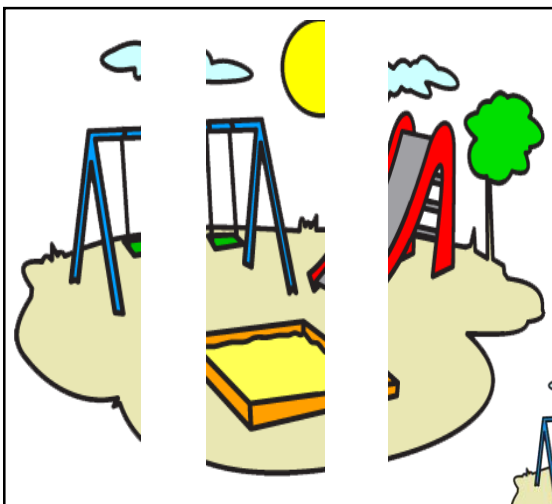

ПЛОЩАДКА

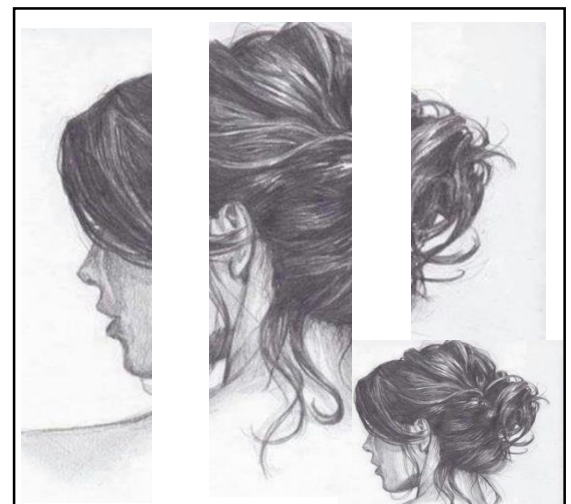

ПРИЧЕСКА



Травкина Ж.А

Сложи слово 14 класс.

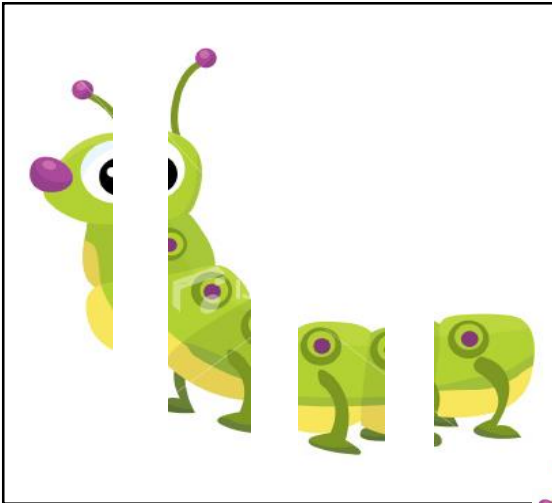

ГУСЕНИЦА



ЯЦЕРИЦА



ПУГОВИЦА



ЖУЖЕЛИЦА



Травкина Ж.А

Сложи слово 14 класс.

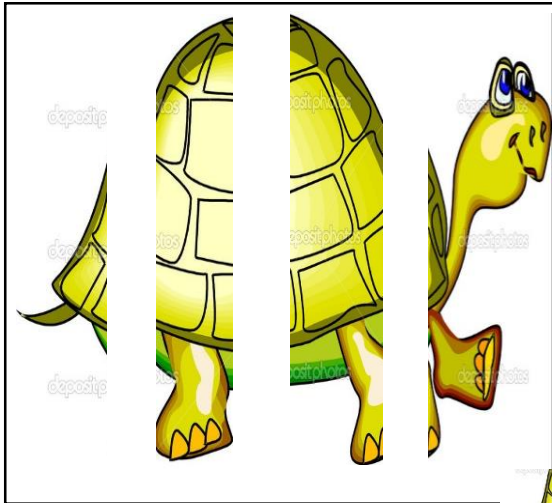

ЧЕРЕПАХА

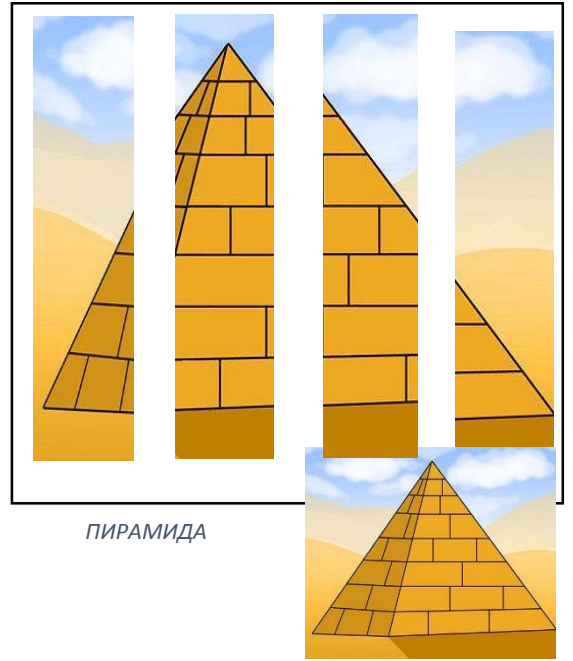
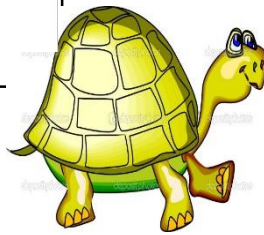

ПИРАМИДА



ПИАНИНО

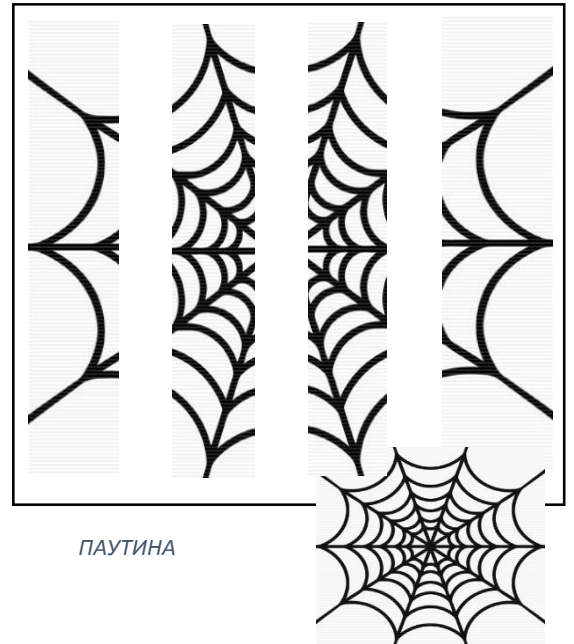

ПАУТИНА



МАКАРОНЫ



ОДЕЯЛО

